

Technical Sheet / Datos técnicos:

Reference adaptable to / Referencia adaptable a :	85107279
Operating temperature range / Rango de temperatura:	- 40 °C a/to 80 °C
Weight / Peso:	60,5 gr

PIN 1	GND/MASA
PIN 2	SIGNAL/SEÑAL
PIN 3	+5V

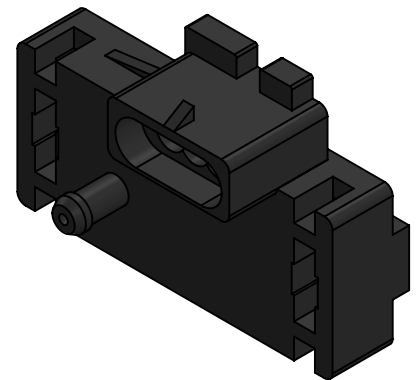
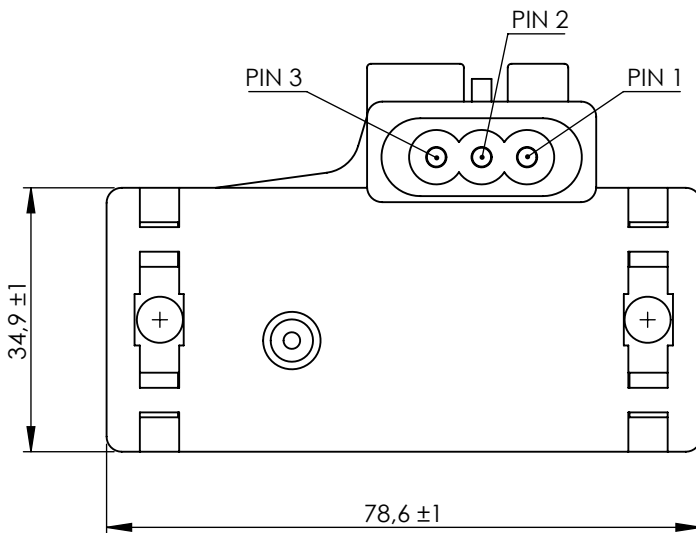
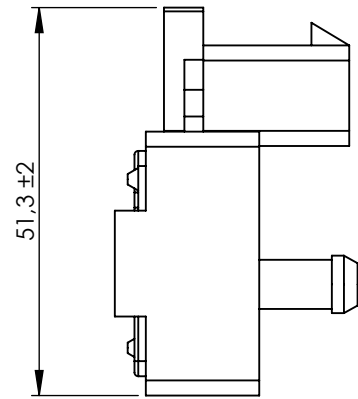
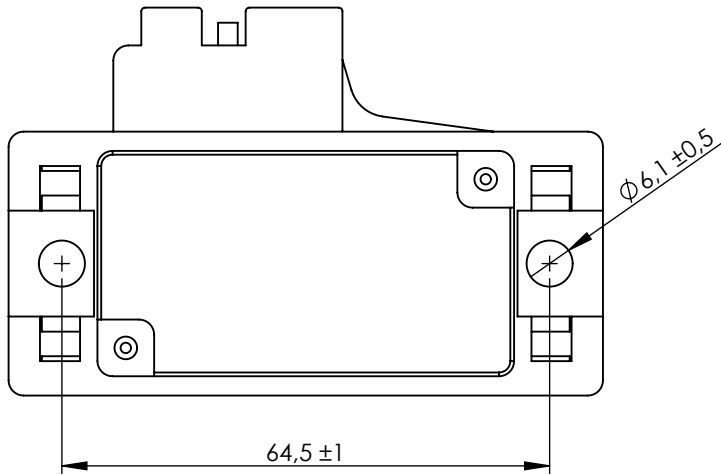

F	Modification	4				Drawn	
		3				31/07/20 S.F.	
		2				Checked	
		1				31/07/20 E.L.	
		nº	Modified	Date	Reason	General Tolerance	
Comments					ISO 2768 c-K	Part name	Boost pressure sensor/Sensor MAP
					Material	ID. Reference	2260385
					-	Scale: 1/1	
					-	Review: 0	