

## Technical Sheet / Datos Técnicos:

Part number adaptable to / Referencia adaptable a:	LA 8126
Safety valve pressure / Presión válvula de seguridad:	13 bar
Unloader / Regulador de presión:	Integrated / Integrado
Cut-out pressure / Presión de corte:	10.5±0.3 bar
Heating / Calentador:	100W / 24 V
Permissible Medium / Medio de funcionamiento:	Air / Aire
Operating temperature range / Rango de temperatura:	- 40°C a / to +80°C
Cut-in temperature / Temperatura de cierre:	+7° ± 6°C
Cut-off temperature / Ajuste de la temperatura:	+29.5° ± 4°C
Weight / Peso:	3143 gr

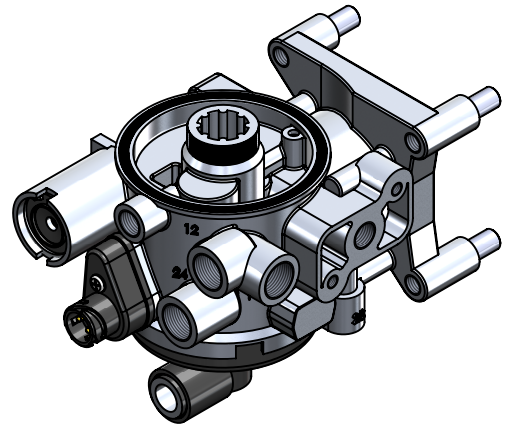

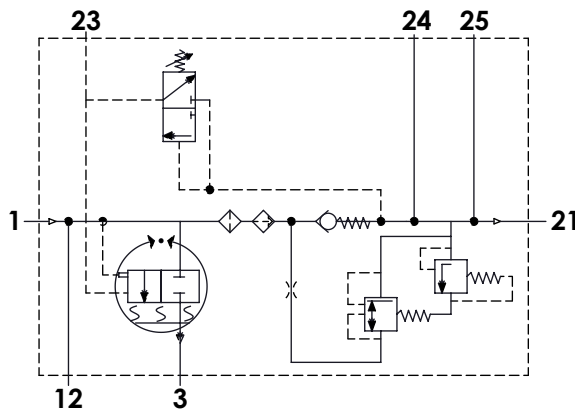

Port / Conexión	Function / Función	Thread / Rosca
1	From the compressor / Proveniente del compresor	M22x1,5
12	External filling / Llenado exterior	M22x1,5
21	To the reservoirs / A los calderines	M16x1,5
23	Control port / Puerto de control	M16x1,5
24	Auxiliar output / Salida auxiliar	M22x1,5
25	Auxiliar output / Salida auxiliar	M16x1,5
3	Exhaust for compressed air / Escape de aire comprimido	For tube Ø16/ Para tubo Ø16
6	Heating / Calentador	Bayonet DIN 72585 A1-2.1

**Purpose / Finalidad:** Drying of the compressed air supplied by the compressor. /  
Secado del aire comprimido procedente del compresor.

**Installation / Instalación:** Exhaust (3) must look down. /  
El escape de aire (3) debe estar orientado hacia abajo.

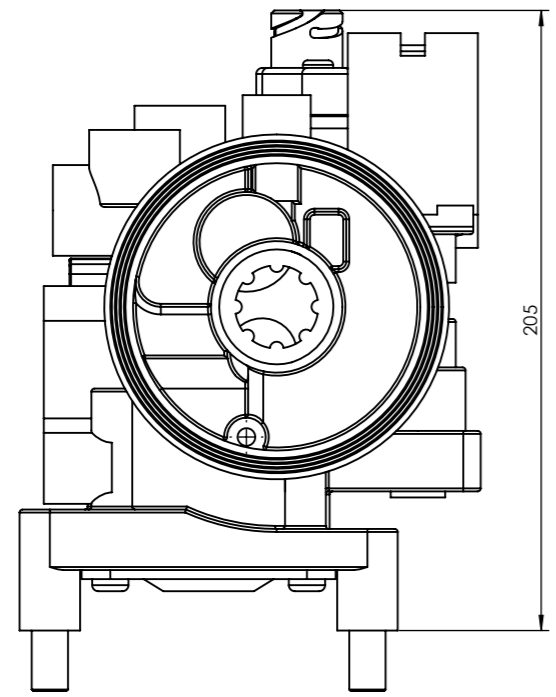
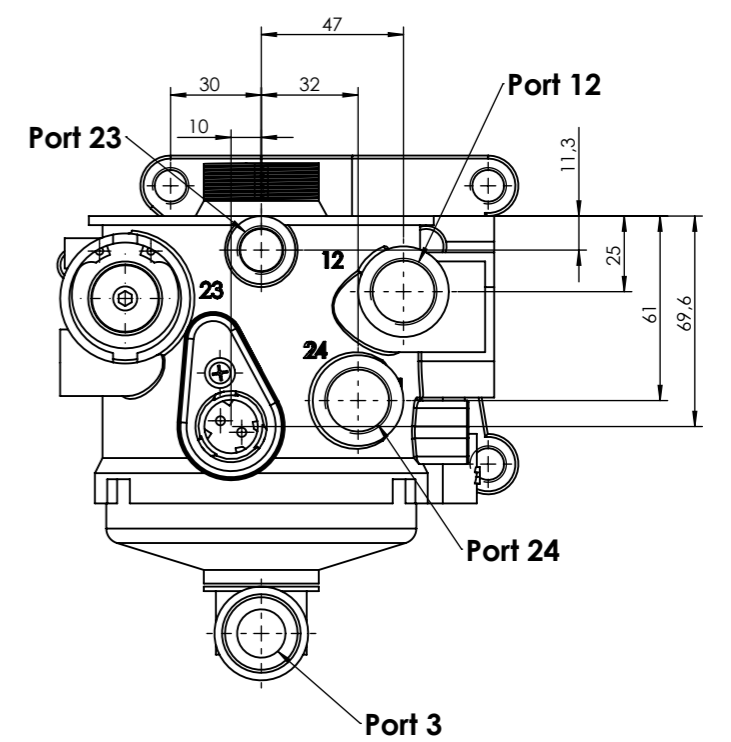
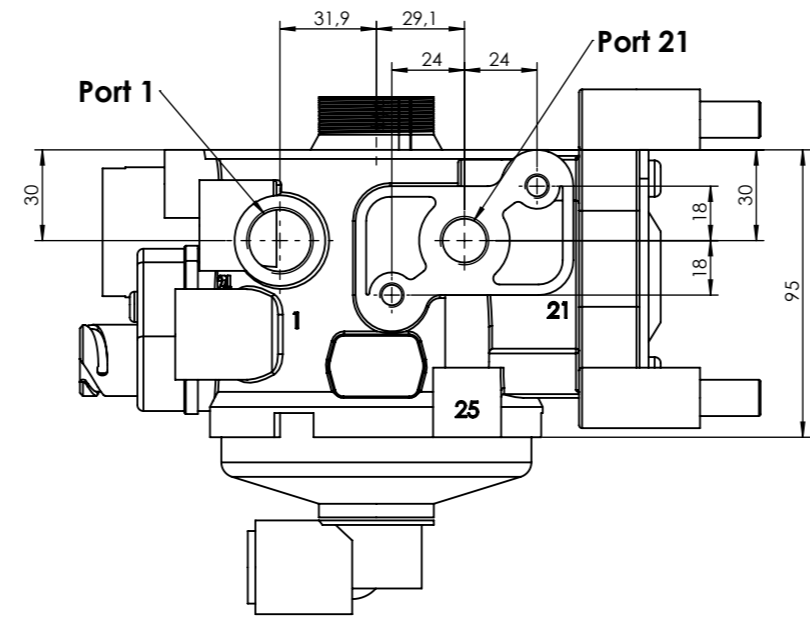
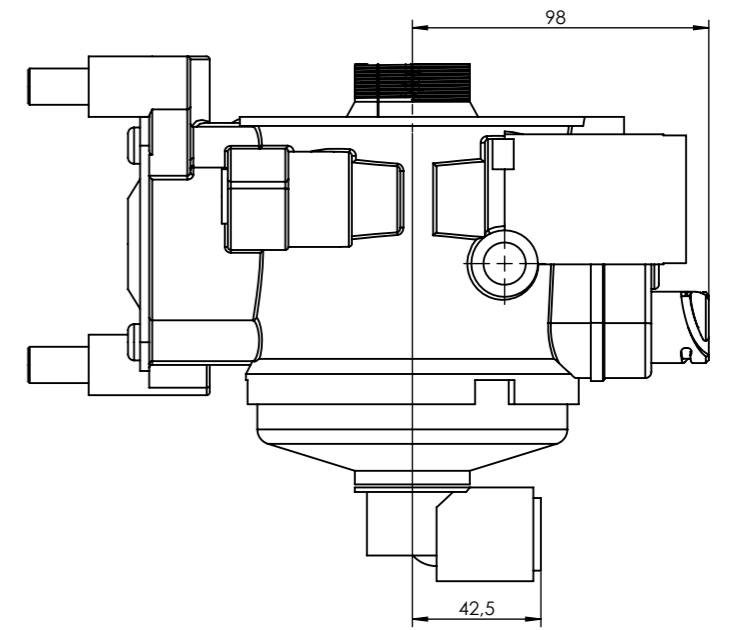
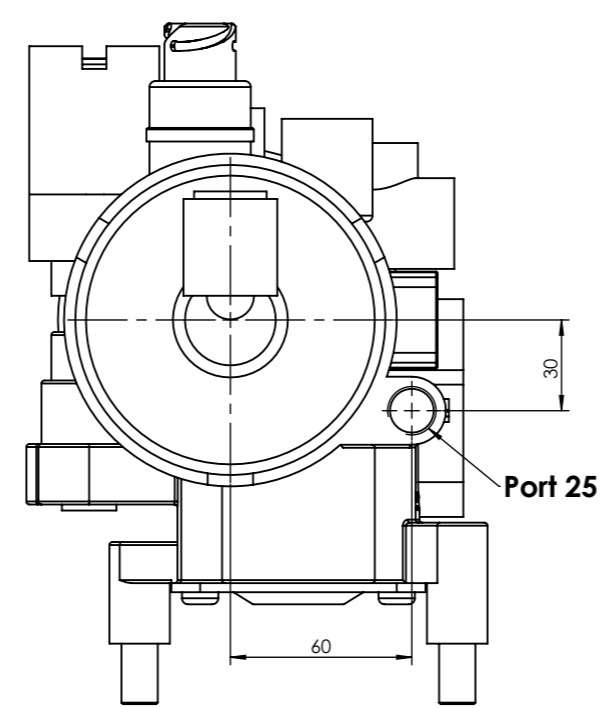
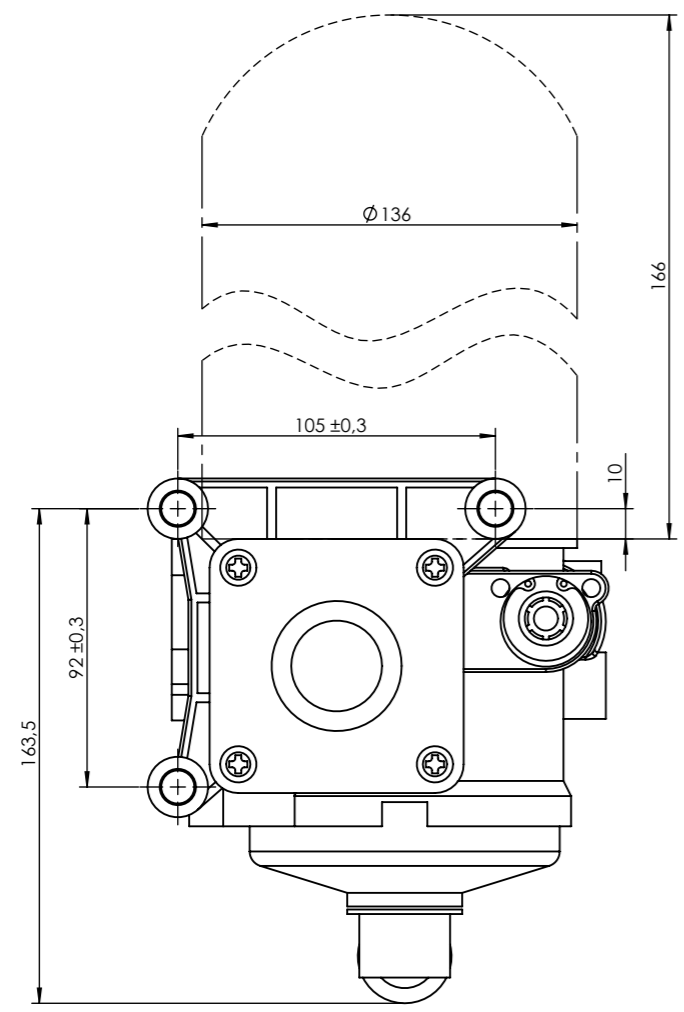
Modification	4				Drawn		
	3				22/07/14 A.U.		
	2				Checked		
	1				22/07/14 A.L.		
F	nº	Modified	Date	Reason	General Tolerance	Assembly	
	Comments				-	Part name	Air Dryer / Secador de aire
					Material	ID. Reference	2310536
					-	Scale: -	
				-	Review: 0	Sheet 1/2	

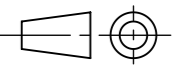

Modification	4			Drawn		F
	3			22/07/14 A.U.		
	2			Checked		
	1			22/07/14 A.L.		
	nº Modified	Date	Reason	General Tolerance	Assembly	-
	Comments			ISO 2768 c-K	Part name	Air Dryer / Secador de aire
				Material	ID. Reference	2310536
					Scale: -	
					Review: 0	