

Technical Sheet / Datos técnicos:

Operating temperature range / Rango de temperatura:	- 40°C a / to +80°C
Weight / Peso:	216 g

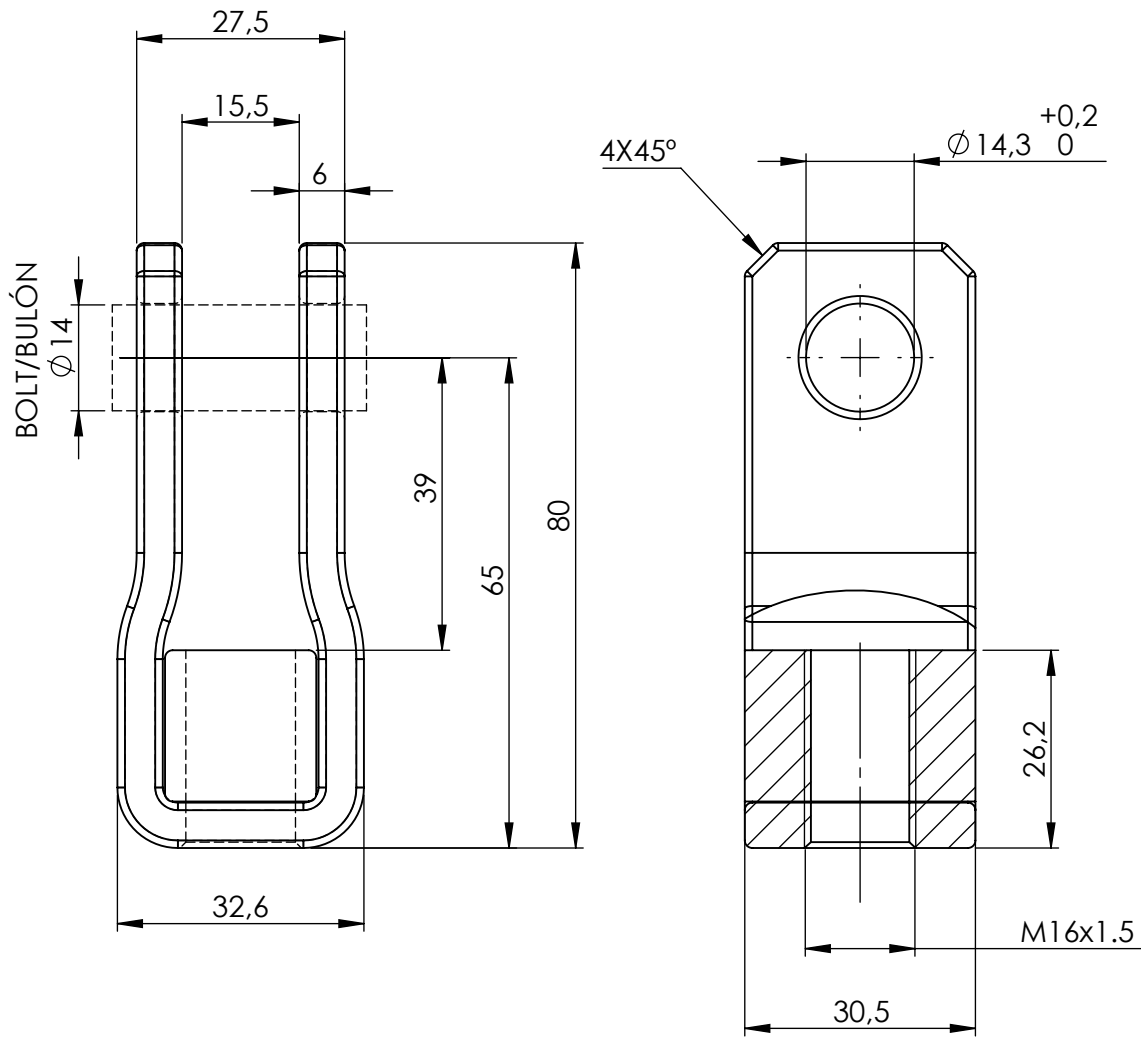

Modification	4				Drawn	
	3				27/09/16 A.U.	
	2				Checked	
	1				27/09/16 A.L.	
	nº	Modified	Date	Reason	General Tolerance	Assembly
Comments					ISO 2768 c-K	Part name
					Material	ID. Reference
					-	Scale: 1/1
					-	Review: 0

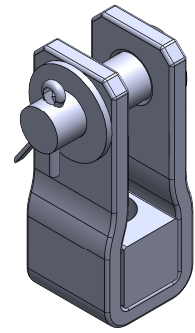

YOKE BOLT 14 mm / HORQUILLA BULÓN 14 mm

2351515

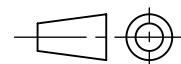

Sheet 1/2