

**EN**



**ES**



**FR**



**IT**



**PT**





## High-pressure fuel circuit test kit

User manual

[jaltest.com](http://jaltest.com)



Rev. 01



## High-pressure fuel circuit test kit

User manual

**cojali**

INNOVATION & TECHNOLOGY



# Index

Index	3
General information	4
Component installation procedure	5
Procedure with diagnostics tool	9
Subsequent steps	10
Warnings and cautions	11

## Easy navigation

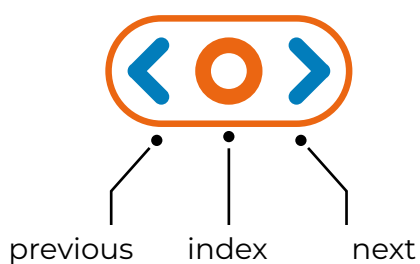

Faster access  
to any content  
you need by  
clicking



# 1 General information

## 1.1 PRODUCT DESCRIPTION

Kit of accessories to carry out fuel return verifications of the injectors and the rail fuel pressure relief valve.

## 1.2 EQUIPMENT COMPOSITION

**1.** Test hose A. Used for connection in the rail fuel pressure relief valve.

**2.** Blind cap. Used for return fuel pipe of the rail pressure relief valve.

**3.** Test hose B. Used for connection in the injector fuel return.

**4.** Adapter. Used for connection in the injector fuel return.

**5.** Shutter for injector. Used to cancel one of the injectors.



## 1.3 APPLICATION

Paccar **MX13** engines controlled by the **PCI engine control system** and installed in different brands of different types of vehicles. For example:

- Implements and harvest equipment: VERVAET
- Bus: IRIZAR, OTOKAR, SOLARIS, TEMSA, VAN HOOL, VDL, YUTONG
- Truck: DAF, TATRA
- OHW: SPIERINGS
- Manufacturers: PACCAR



## 2 Component installation procedure

**Warning:** Take the appropriate precautions before carrying out works in the fuel system (see section 4).

### 2.1 CONNECTION IN THE FUEL PRESSURE RELEASE PIPE

- Open the grille and tilt the cabin.
- Loosen the fixing clamps and the nut of the rail pressure release pipe.



- Thread the test hose “1” into the connection of the rail fuel release pipe. Recommended tightening torque 30Nm. The other end of the hose should be inserted into a calibrated container for measuring the volume.

**Note:** Prevent the pipe from bending.

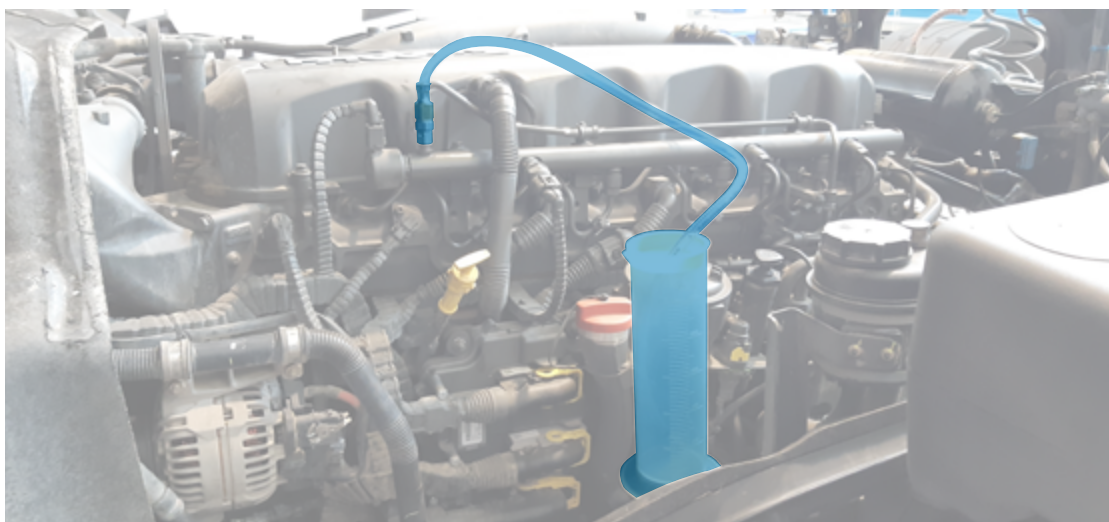

- Thread the blind cap “2” into the end of the pipe. Recommended tightening torque 30Nm.



## 2.2 CONNECTION IN THE INJECTOR FUEL RETURN

- Release the fuel return pipe from the injectors by loosening the fixing clamp and the hollow screw of the fitting.

**Note:** Collect the sealing washers.

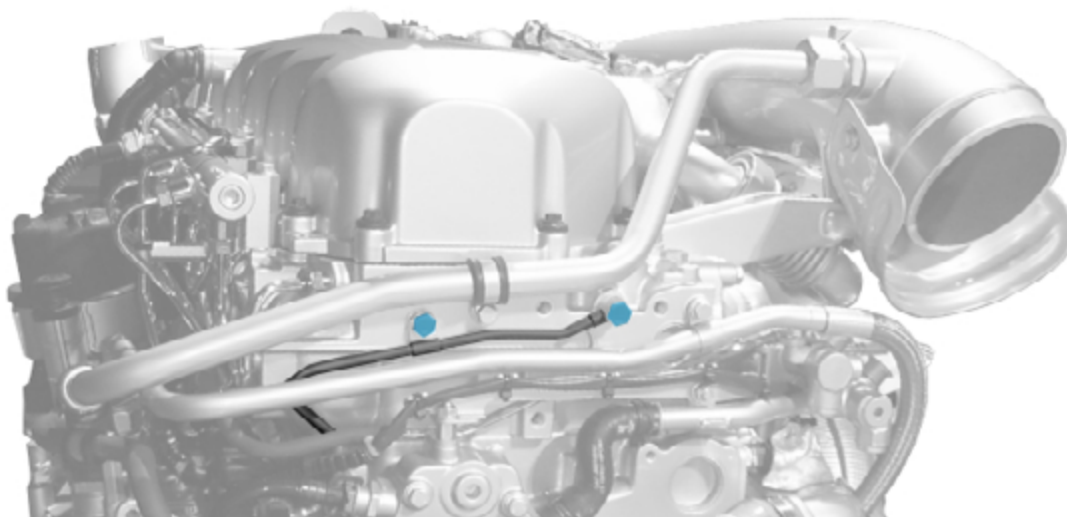

- Install the adapter “4” with the fitting instead of the hollow screw and use the sealing washers. Recommended tightening torque 16Nm.
- Connect one end of the test hose “3” to the adapter “4”. The other end of the hose should be inserted into a calibrated container for measuring the volume.

**Note:** The calibrated container must be positioned so that its height is higher than the connection point of the adapter.

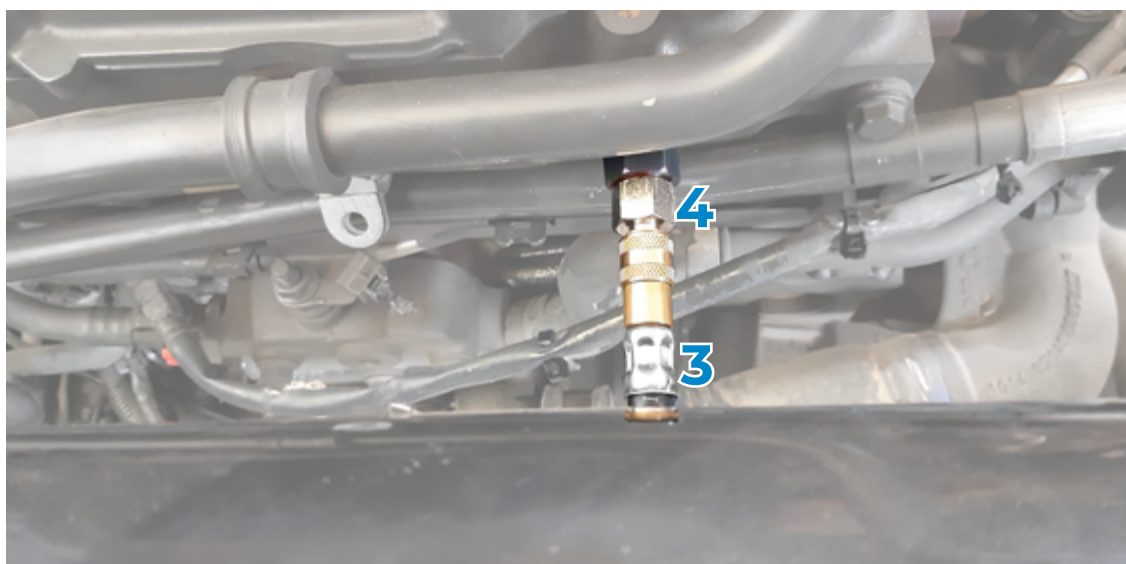

- 4 Adapter
- 3 End of the test hose B



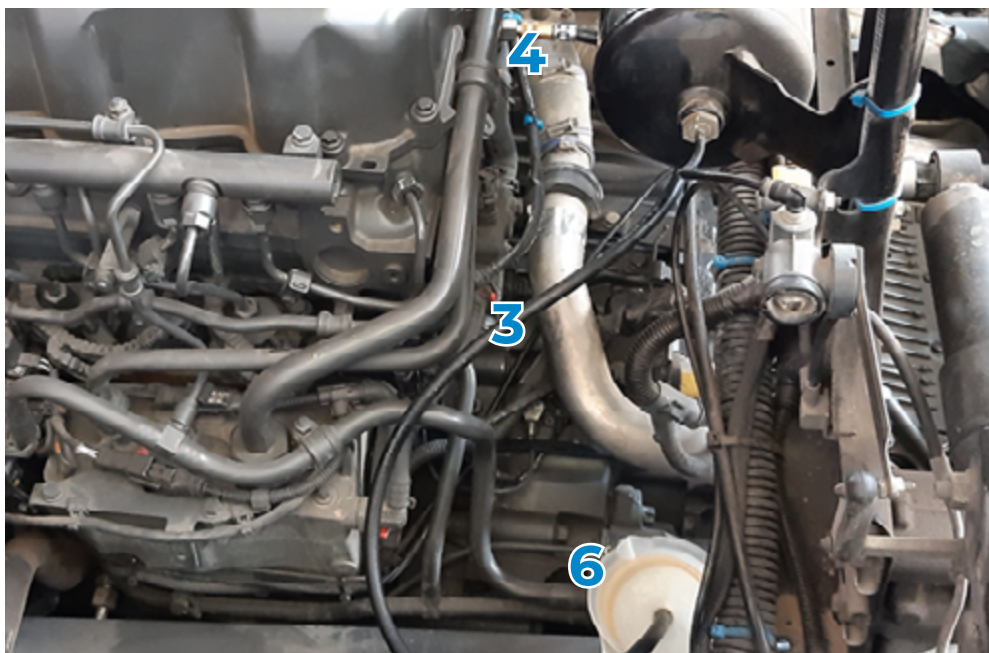

- 4 Adapter
- 3 Test hose B
- 6 Calibrated container

## 2.3 PURGE THE FUEL SYSTEM

- Loosen the controller of the manual fuel supply pump by turning it anticlockwise.

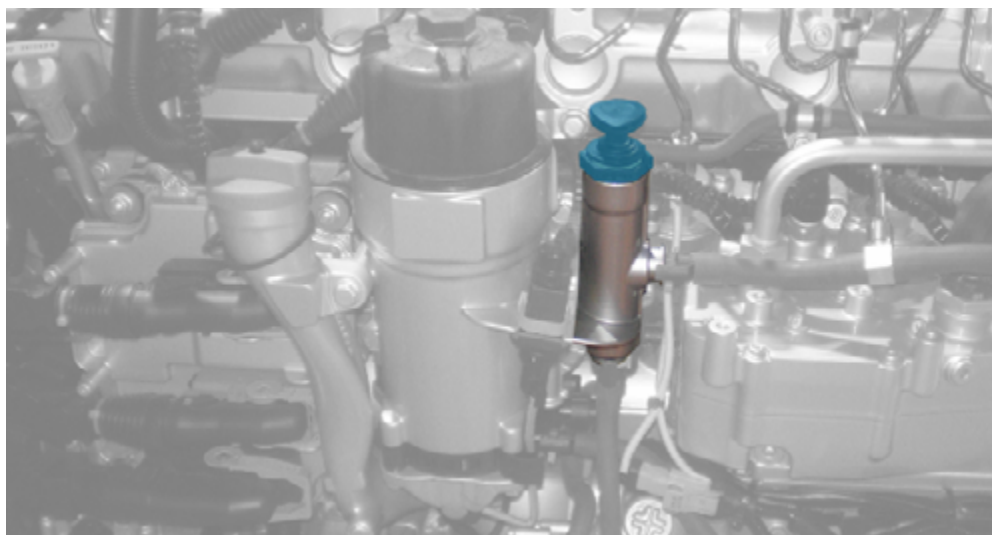

- Activate the pump until it pressurises the circuit and motion resistance is detected.
- Tighten the controller of the manual fuel supply pump by turning it to the right.
- Start the engine and keep it at idle for a few minutes so that it expels the air from the fuel circuit.
- Collect and dispose of the fuel that may have dropped into the calibrated containers.



## 3 Procedure with diagnostics tool

- Carry out the following system check and pay attention to the additional information provided:

**PCI system>>System checks>>“HIGH PRESSURE CIRCUIT”>>“PUMP UNIT”**

- Carry out the following system check and pay attention to the additional information provided:

**PCI system>>System checks>>“HIGH PRESSURE CIRCUIT”>>“FUEL RETURN OF THE INJECTORS”**

**Note:** Use the shutter for injector “5” if you want to carry out the test with one of the disconnected cylinders. To do this, it is necessary to disassemble the corresponding injector pipe and thread the shutter for injector “5” on the side of the rail. Recommended tightening torque:

- 1st phase 15Nm
- 2nd phase 30°





## 4 Subsequent steps

- Drain the fuel from the hoses and dispose of it together with the fuel from containers.
- Uninstall the components, clean up any spilled fuel and assemble the vehicle components taking into account the recommended tightening torques:
  - Connection in the rail fuel pressure release pipe: 30Nm
  - Fixing clamp screws: 30Nm
  - Hollow screw along with fitting and sealing washers: 16Nm
- **Note:** It is advisable to replace the sealing washers.
- Injector pipes:
  - Cylinder head side: 1st phase 27Nm and 2nd phase 30°
  - Rail side: 1st phase 15Nm and 2nd phase 30°
- Purge the fuel system as indicated in step 2.3.
- Lower the cabin and close the grille.
- Carry out a road test and check that there are no fuel leaks.



# 5 Warnings and cautions

Warnings and cautions for working with fuel:

- Avoid contact with eyes and skin, inhalation and ingestion.
- Avoid generation of vapours, spillages and mixture with other fuels. This can be an explosive mixture.
- Stop the test if a leak or any other potential hazard is detected.
- Ensure adequate ventilation of the working area and only with the necessary workers properly uniformed with protective clothing and accessories.
- Keep all possible ignition sources away from fuel.
- Do not handle the component gaskets. Use appropriated gloves.

# ●.cojali

Jaltest.com  
cojali.com

2022 V.1 EN



Local Distributor



**Kit para comprobación  
del circuito de alta presión  
de combustible**

Manual de usuario

[jaltest.com](http://jaltest.com)

**cojali**  
INNOVATION & TECHNOLOGY



Rev. 01



**Kit para comprobación  
del circuito de alta presión  
de combustible**

Manual de usuario

**cojali**

INNOVATION & TECHNOLOGY



# Índice

Índice	3
Información general	4
Procedimiento de instalación de componentes	5
Procedimiento con herramienta de diagnóstico	9
Pasos posteriores	10
Advertencias y precauciones	11

## Fácil navegación

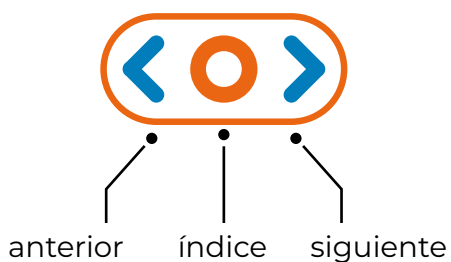

Accede más rápidamente al contenido que necesite haciendo clic



# 1 Información general

## 1.1 DESCRIPCIÓN DEL PRODUCTO

Se trata de un conjunto de accesorios para realizar comprobaciones de retorno de combustible de los inyectores y de la válvula de control de presión de combustible en el raíl.

## 1.2 COMPOSICIÓN DEL EQUIPO

1. Manguera de comprobación A. Para conexión en la válvula de control de presión de combustible en el raíl.
2. Tapón ciego. Para tubería de combustible de retorno de la válvula de control de presión del raíl.
3. Manguera de comprobación B. Para conexión en el retorno de combustible de los inyectores.
4. Adaptador. Para conexión en el retorno de combustible de los inyectores.
5. Obturador para inyector. Para anular uno de los inyectores.



## 1.3 APLICACIÓN

Motores **MX13** de Paccar controlados por el **sistema de gestión motor PCI** y montados en diferentes marcas de diferentes tipos de vehículo. Por ejemplo:

- Aperos y equipo de cosecha: VERVAET
- Autobús: IRIZAR, OTOKAR, SOLARIS, TEMSA, VAN HOOL, VDL, YUTONG
- Camión: DAF, TATRA
- OHW: SPIERINGS
- Fabricantes: PACCAR



## 2 Procedimiento de instalación de componentes

**Advertencia:** tomar las precauciones adecuadas para realizar trabajos en el sistema de combustible (consultar punto 4).

### 2.1 CONEXIÓN EN TUBERÍA DE DESCARGA DE PRESIÓN DE COMBUSTIBLE

- Abrir la calandra y abatir la cabina.
- Aflojar las grapas de sujeción y la tuerca de la tubería de descarga de presión del raíl.



- Roscar la manguera de comprobación “1” en la conexión de la tubería de descarga de combustible del raíl. Par de apriete recomendado 30 Nm. El otro extremo de la manguera debe introducirse en un recipiente calibrado para la medición del volumen.

**Nota:** evitar doblar la tubería.

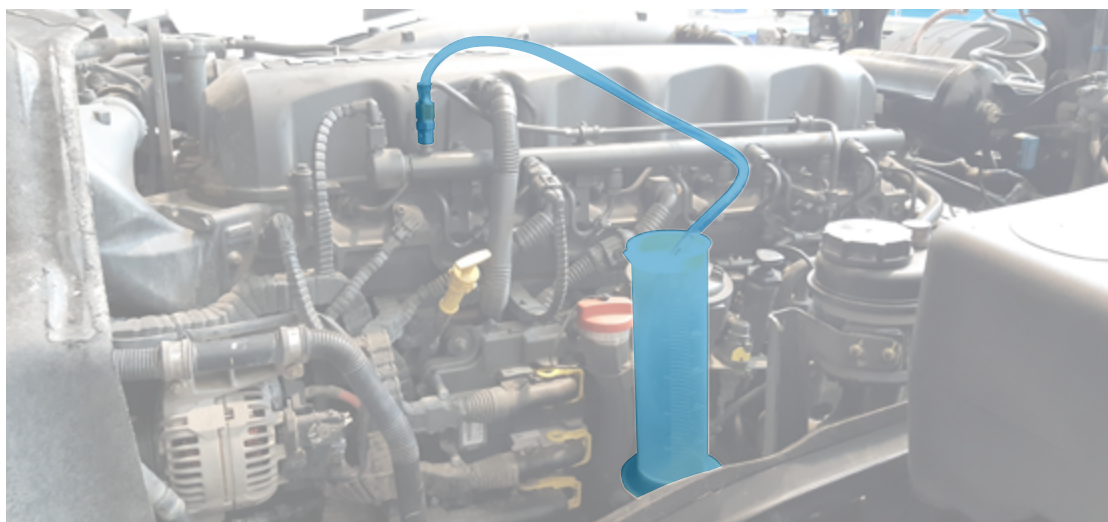

- Roscar el tapón ciego “2” al extremo de la tubería. Par de apriete recomendado 30 Nm.



## 2.2 CONEXIÓN EN RETORNO DE COMBUSTIBLE DE LOS INYECTORES

- Liberar la tubería de retorno de combustible de los inyectores aflojando la grapa de sujeción y el tornillo hueco del racor.

**Nota:** recoger las arandelas de estanqueidad.

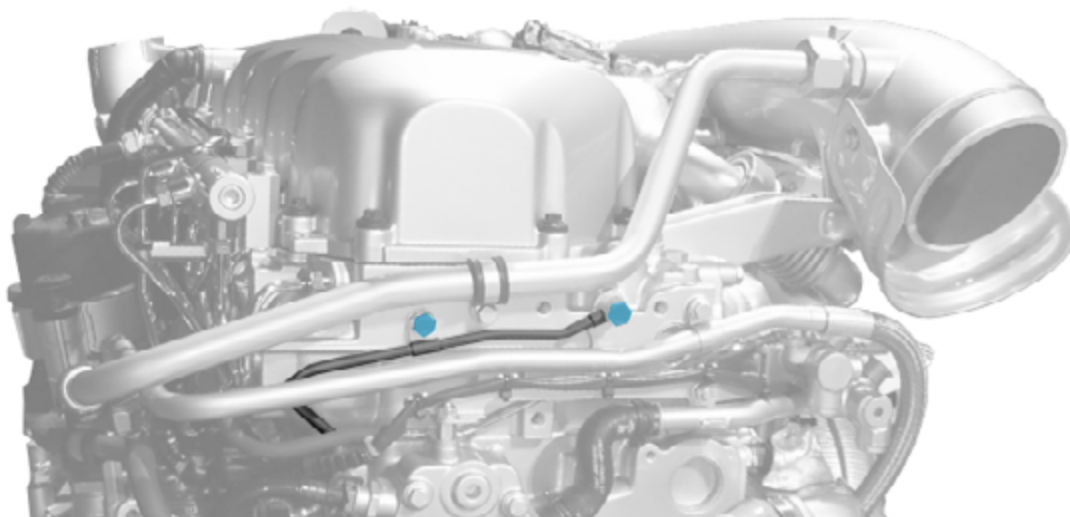

- Instalar el adaptador “4” con el racor en lugar del tornillo hueco y utilizar las arandelas de estanqueidad. Par de apriete recomendado 16 Nm.
- Conectar un extremo de la manguera de comprobación “3” en el adaptador “4”. El otro extremo de la manguera debe introducirse en un recipiente calibrado para medición de volumen.

**Nota:** el recipiente calibrado debe colocarse de manera que su altura sea superior al punto de conexión del adaptador.

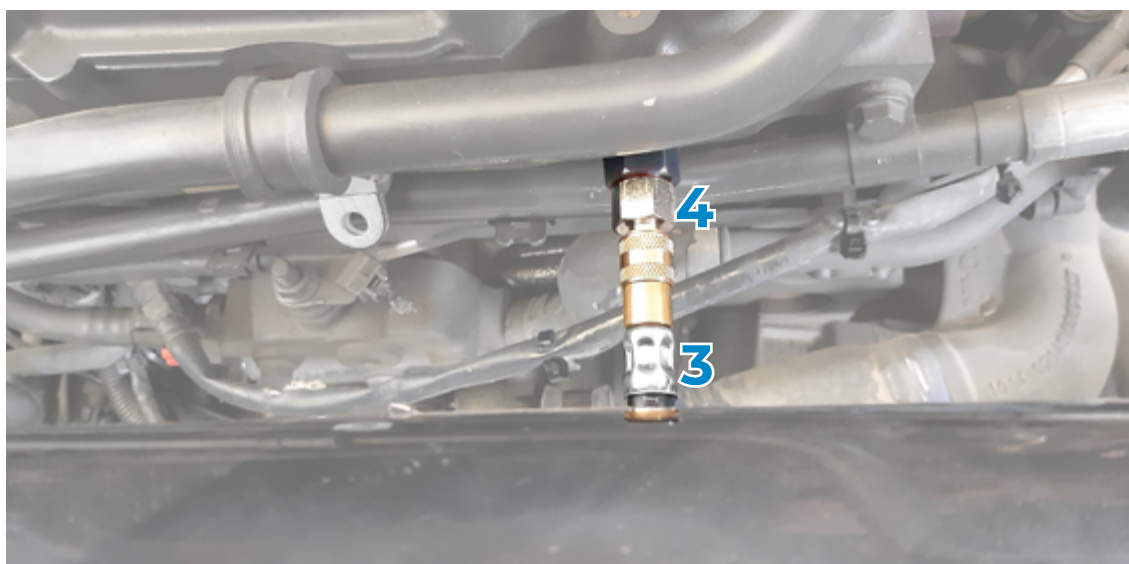

- 4 Adaptador
- 3 Extremo de la manguera de comprobación B

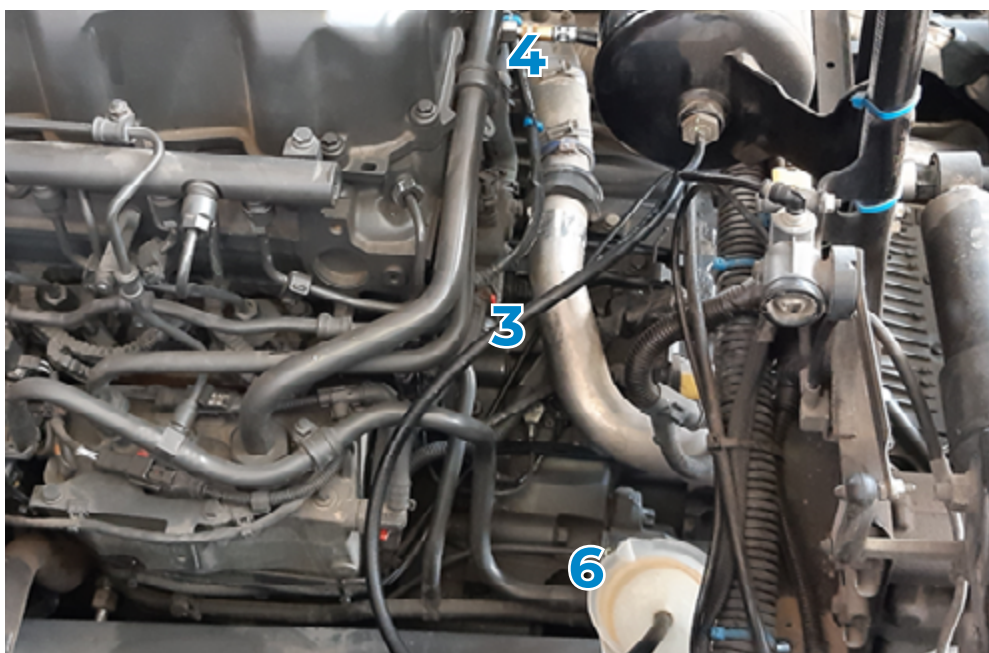

- 4 Adaptador
- 3 Manguera de comprobación B
- 6 Recipiente calibrado

## 2.3 PURGAR EL SISTEMA DE COMBUSTIBLE

- Aflojar el mando de la bomba manual de alimentación de combustible girando en sentido antihorario.

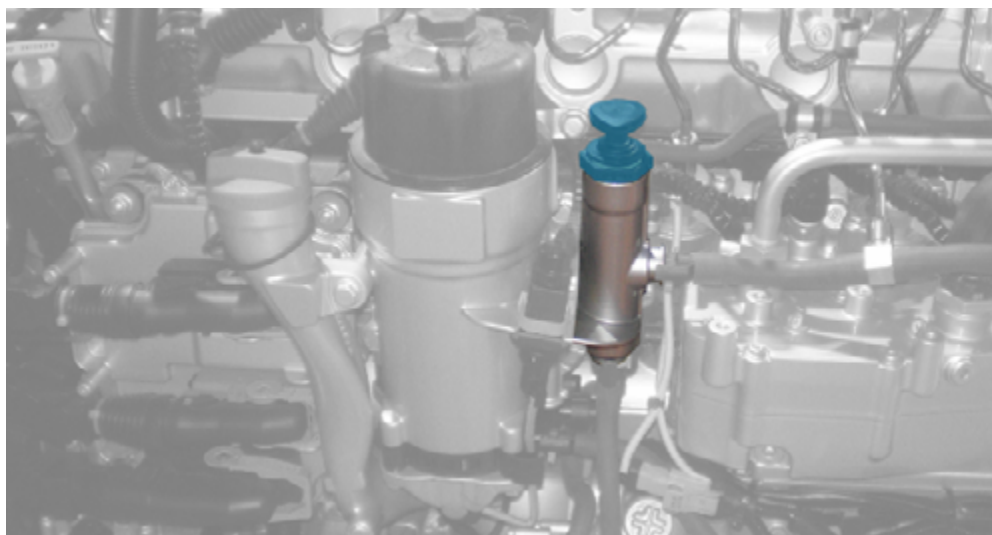

- Accionar la bomba hasta que presurice el circuito y se aprecie resistencia al movimiento.
- Apretar el mando de la bomba manual de alimentación de combustible girando hacia la derecha.
- Arrancar el motor y permanecer en ralentí durante unos minutos para que expulse el aire del circuito de combustible.
- Recoger y desechar el combustible que haya podido caer en los recipientes calibrados.



## 3 Procedimiento con herramienta de diagnóstico

- Llevar a cabo el siguiente chequeo del sistema y prestar atención a la información adicional que se proporciona:

**Sistema PCI>>Chequeos del sistema>>“CIRCUITO DE ALTA PRESIÓN”  
>>“UNIDAD DE BOMBEO”**

- Llevar a cabo el siguiente chequeo del sistema y prestar atención a la información adicional que se proporciona:

**Sistema PCI>>Chequeos del sistema>>“CIRCUITO DE ALTA PRESIÓN”  
>>“RETORNO DE COMBUSTIBLE DE LOS INYECTORES”**

**Nota:** utilizar el obturador para inyector “5” si se desea realizar la prueba con uno de los cilindros desconectados. Para ello será necesario desmontar la tubería del inyector que corresponda y roscar el obturador para inyector “5” en el lado del raíl. Par de apriete recomendado:

- 1ª fase 15 Nm
- 2ª fase 30°





## 4 Pasos posteriores

- Drenar el combustible de las mangueras y desecharlo junto al de los recipientes.
  - Desinstalar los componentes, limpiar el combustible derramado y montar los componentes del vehículo teniendo en cuenta los pares de apriete recomendados:
    - Conexión de la tubería de descarga de presión de combustible del raíl: 30 Nm
    - Tornillos de las grapas de sujeción: 30 Nm
    - Tornillo hueco junto a racor y arandelas de estanqueidad: 16 Nm
- Nota:** es recomendable sustituir las arandelas de estanqueidad.
- Tuberías de los inyectores:
    - Lado de la culata: 1ª fase 27 Nm y 2ª fase 30°
    - Lado del raíl: 1ª fase 15 Nm y 2ª fase 30°
  - Purgar el sistema de combustible como se indica en el paso 2.3.
  - Bajar la cabina y cerrar la calandra.
  - Llevar a cabo una prueba en carretera y revisar que no existen fugas de combustible.



# 5 Advertencias y precauciones

Precauciones y advertencias para trabajos con combustible:

- Evitar el contacto con ojos y piel, inhalación e ingestión.
- Evitar que se generen vapores, derramamientos y mezclas con otros combustibles. Esto puede suponer una mezcla explosiva.
- Detener la prueba si se detecta una fuga o cualquier otro posible peligro.
- Mantener la zona de trabajo ventilada y solamente con las personas necesarias debidamente uniformadas con ropa y accesorios de protección.
- Mantener todas las posibles fuentes de encendido alejadas del combustible.
- No tocar las juntas de los componentes. Utilizar guantes apropiados.



# ●.cojali

Jaltest.com  
cojali.com

2022 V.1 ES



Local Distributor



**Kit pour la vérification du  
circuit de haute pression  
de carburant**

Manuel de l'utilisateur

[jaltest.com](http://jaltest.com)

**cojali**

INNOVATION & TECHNOLOGY



Rev. 01



## Kit pour la vérification du circuit de haute pression de carburant

Manuel de l'utilisateur

**cojali**

INNOVATION & TECHNOLOGY



# Sommaire

Sommaire	3
Information générale	4
Procédé d'installation de composants	5
Procédé avec l'outil de diagnostic	9
Étapes suivantes	10
Avertissements et précautions	11

## Navigation facile

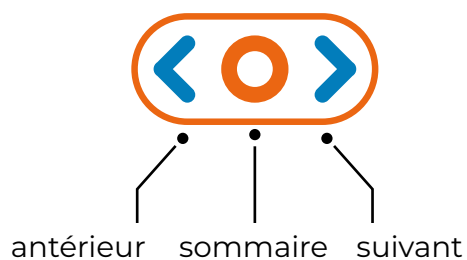

Accédez plus rapidement au contenu dont vous avez besoin en faisant clic

# 1 Information générale

## 1.1 DESCRIPTION DU PRODUIT

Il s'agit d'un ensemble d'accessoires pour réaliser les vérifications de retour de carburant des injecteurs et de la valve de contrôle de pression de carburant dans le rail.

## 1.2 COMPOSITION DE L'ÉQUIPEMENT

1. Tuyau de vérification A. Pour connexion à la valve de contrôle de pression de carburant dans le rail.

2. Bouchon aveugle. Pour tuyau de retour de carburant de la valve de contrôle de pression du rail.

3. Tuyau de vérification B. Pour connexion au retour de carburant des injecteurs.

4. Adaptateur. Pour connexion au retour du carburant des injecteurs.

5. Obturateur pour injecteur. Pour annuler un des injecteurs.



## 1.3 APPLICATION

Moteurs **MX13** de Paccar contrôlés par le **système de gestion moteur PCI** et montés sur différentes marques de divers types de véhicule. Par exemple :

- Outils et équipement de récolte : VERVAET
- Autobus : IRIZAR, OTOKAR, SOLARIS, TEMSA, VAN HOOL, VDL, YUTONG
- CAMION : DAF, TATRA
- OHW : SPIERINGS
- Fabricants : PACCAR



## 2 Procédé d'installation de composants

**Avertissement :** prendre les précautions appropriées pour réaliser les travaux sur le système à carburant (consulter le point 4).

### 2.1 CONNEXION AU TUYAU DE DÉCHARGE DE PRESSON DE CARBURANT

- Ouvrir la calandre et basculer la cabine.
- Desserrer les agrafes de fixation et l'écrou du tuyau de décharge de pression du rail.



- Visser le tuyau de vérification "1" à la connexion du tuyau de décharge de carburant du rail. Couple de serrage recommandé 30 Nm. L'autre extrémité du tuyau doit être introduite dans un récipient gradué pour la mesure de volume.

**Note :** éviter de plier le tuyau.

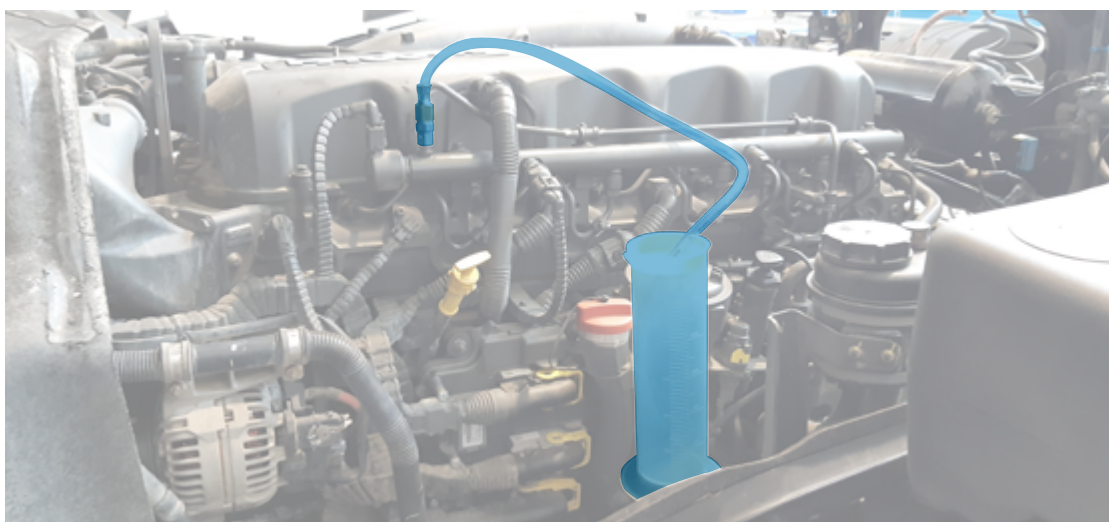

- Visser le bouchon aveugle “2” à l’extrémité du tuyau. Couple de serrage recommandé 30 Nm.



## 2.2 CONNEXION AU RETOUR DU CARBURANT DES INJECTEURS

- Libérer le tuyau de retour de carburant des injecteurs en desserrant l’agrafe de fixation et la vis creuse du raccord.

**Note:** Ramasser les rondelles d’étanchéité.

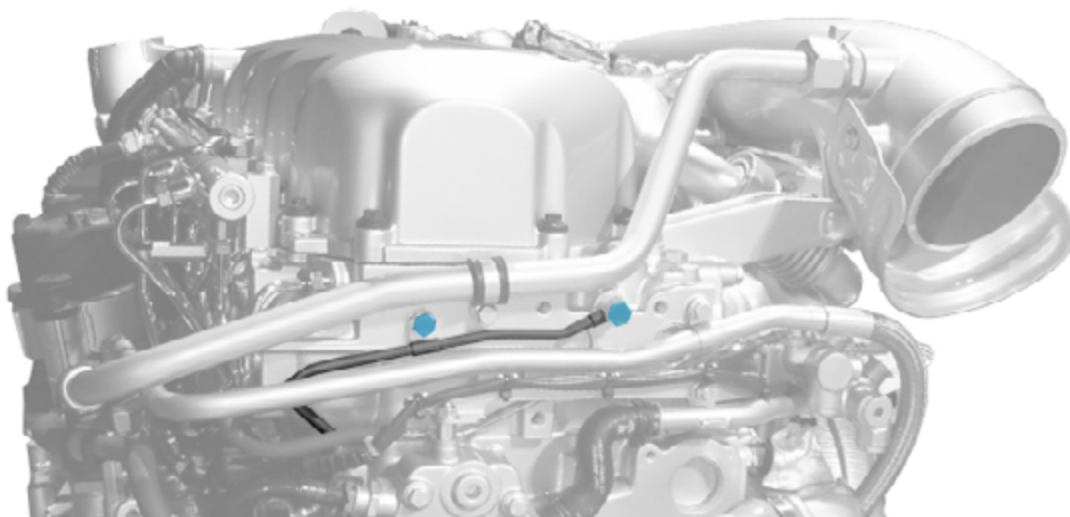

- Installer l'adaptateur "4" avec le raccord au lieu de la vis creuse et utiliser les rondelles d'étanchéité. Couple de serrage recommandé 16 Nm.
- Connecter une extrémité du tuyau de vérification "3" à l'adaptateur "4". L'autre extrémité du tuyau doit être introduite dans un récipient gradué pour la mesure du volume.

**Note :** le récipient gradué doit être placé de telle façon que sa hauteur soit supérieure au point de connexion de l'adaptateur.

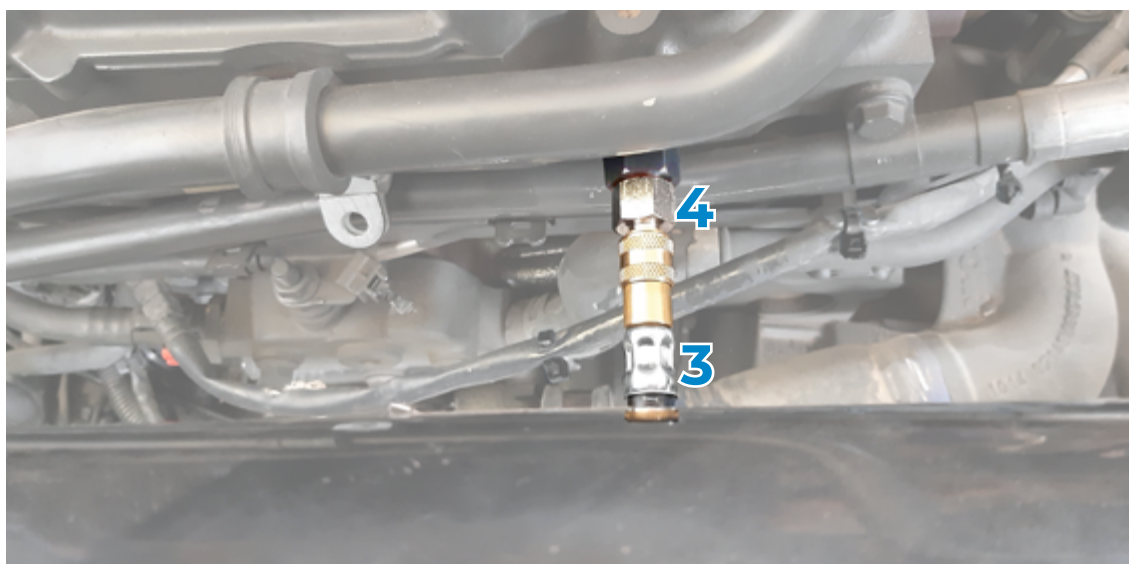

- 4 Adaptateur
- 3 Extrémité du tuyau de vérification B



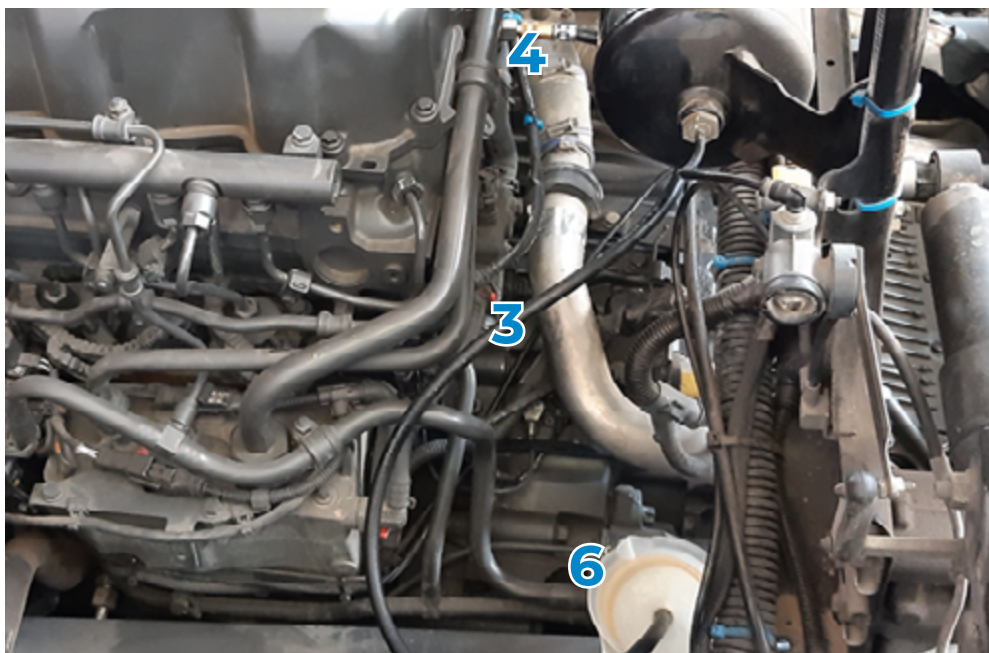

- 4 Adaptateur
- 3 Tuyau de vérification B
- 6 Récipient gradué

## 2.3 PURGER LE SYSTÈME À CARBURANT

- Desserrer la commande de la pompe d'alimentation manuelle de carburant en tournant dans le sens antihoraire.

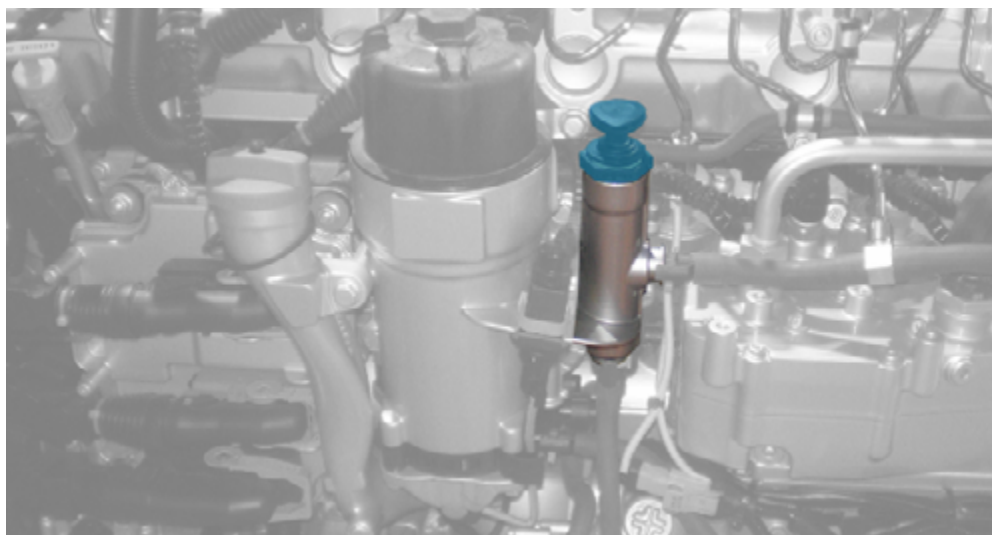

- Actionner la pompe jusqu'à ce que le circuit pressurise et que de la résistance au mouvement est remarquée.
- Serrer la commande de la pompe d'alimentation manuelle de carburant en tournant vers la droite.
- Démarrer le moteur et rester au ralenti pendant quelques minutes pour que l'air du circuit de carburant soit expulsé.
- Ramasser et jeter le carburant qui a pu tomber dans les récipients gradués.

## 3 Procédé avec l'outil de diagnostic

- Effectuer la vérification suivante du système et faire attention à l'information supplémentaire qui est fournie :

**Système PCI>>Vérifications du système>>“CIRCUIT DE HAUTE PRESSION”>>“UNITÉ DE POMPAGE”**

- Effectuer la vérification suivante du système et faire attention à l'information supplémentaire qui est fournie :

**Système PCI>>Vérifications du système>>“CIRCUIT DE HAUTE PRESSION”>>“RETOUR DE CARBURANT DES INJECTEURS”**

**Note:** Utiliser l'obturateur pour injecteur “5” si l'on souhaite réaliser le test avec un des cylindres déconnectés. Pour ce faire, il faut démonter le tuyau de l'injecteur correspondant et visser l'obturateur pour injecteur “5” sur le côté du rail. Couple de serrage recommandé:

- 1<sup>a</sup> fase 15 Nm
- 2<sup>a</sup> fase 30°





## 4 Étapes suivantes

- Drainer le carburant des tuyaux et le jeter avec celui des récipients.
  - Désinstaller les composants, nettoyer le carburant renversé et monter les composants du véhicule en prenant en considération les couples de serrage recommandés :
    - Connexion du tuyau de décharge de pression de carburant du rail : 30 Nm
    - Vis des agrafes de fixation : 30 Nm
    - Vis creuse avec raccord et rondelles d'étanchéité : 16 Nm
- Note:** Il est recommandé de remplacer les rondelles d'étanchéité.
- Tuyaux des injecteurs :
    - Côté de la culasse : 1ère phase 27 Nm et 2ème phase 30°
    - Côté du rail : 1ère phase 15 Nm et 2ème phase 30°
  - Purger le système à carburant comme il est indiqué sur l'étape 2.3.
  - Baisser la cabine et fermer la calandre.
  - Effectuer un essai en route et réviser qu'il n'y a pas de fuites de carburant.



# 5 Avertissements et précautions

Précautions et avertissements pour les travaux avec du carburant :

- Éviter le contact avec les yeux et la peau, l'inhalation, et l'ingestion.
- Éviter que des vapeurs se génèrent, des renversements et des mélanges avec d'autres carburants. Cela peut former un mélange explosif.
- Arrêter le test si une fuite ou n'importe quel autre danger est détecté.
- Maintenir la zone de travail ventilée et uniquement avec les personnes nécessaires dûment en uniforme avec des vêtements et des accessoires de protection.
- Maintenir toutes les éventuelles sources éloignées du carburant.
- Ne pas toucher les joints des composants. Utiliser les gants appropriés.

# ●.cojali

Jaltest.com  
cojali.com

2022 V.1 IT



Local Distributor



**Kit per la verifica del circuito  
ad alta pressione  
del combustibile**

Manuale Utente

[jaltest.com](http://jaltest.com)

**cojali**

INNOVATION & TECHNOLOGY



Rev. 01



**Kit per la verifica del circuito  
ad alta pressione  
del combustibile**

Manuale Utente

**●.cojali**

INNOVATION & TECHNOLOGY



# Indice

Indice	3
Informazioni generali	4
Procedimento di montaggio dei componenti	5
Procedimento con lo strumento di diagnosi	9
Passaggi successivi	10
Avvertenze e precauzioni	11

## Navigazione facilitata

precedente      indice      seguente

Carlo al dispositivo Jaltest  
diagramas de conexión  
por Activo inter...  
pulsaciones de...  
encendido el led de sensor

3 Diagramas de conexión

FIGURA 1

Acceda più velocemente al contenuto di cui necessita con un clic



# 1 Informazioni generali

## 1.1 DESCRIZIONE DEL PRODOTTO

Si tratta di un insieme di accessori per controllare il ritorno di combustibile degli iniettori e la valvola di controllo della pressione del combustibile nel rail.

## 1.2 COMPOSIZIONE DELL'ATTREZZATURA

**1.** Tubo di verifica A. Per collegamenti nella valvola di controllo della pressione del combustibile nel rail.

**2.** Tappo cieco. Per tubi del combustibile di ritorno della valvola di controllo della pressione del rail.

**3.** Tubo di verifica B. Per collegamenti nel ritorno del combustibile degli iniettori.

**4.** Adattatore. Per collegamenti nel ritorno del combustibile degli iniettori.

**5.** Otturatore per iniettori. Per annullare uno degli iniettori.



## 1.3 APPLICAZIONE

Motori **MX13** di Paccar controllati dal **sistema di gestione del motore PCI** e montati in varie marche di diversi tipi di veicoli. Per esempio:

- Attrezzi e macchine da raccolta: VERVAET
- Autobus: IRIZAR, OTOKAR, SOLARIS, TEMSA, VAN HOOL, VDL, YUTONG
- Camion: DAF, TATRA
- OHW: SPIERINGS
- Fabbricanti: PACCAR

## 2 Procedimento di montaggio dei componenti

**Avvertenza:** per lavorare sull'impianto del combustibile prendere le precauzioni necessarie (consultare punto 4).

### 2.1 COLLEGAMENTO NEL TUBO DI RILASCIO DELLA PRESSIONE DEL COMBUSTIBILE

- Aprire la calandra e ribaltare la cabina.
- Allentare i morsetti di sostegno e il dado del tubo di rilascio della pressione del rail.



- Avvitare il tubo di verifica "1" nel collegamento del tubo di scarico del combustibile del rail. Coppia di serraggio consigliata di 30 Nm. L'altra estremità del tubo deve essere inserita in un recipiente calibrato per la misurazione del volume.

**Note :** non piegare il tubo.

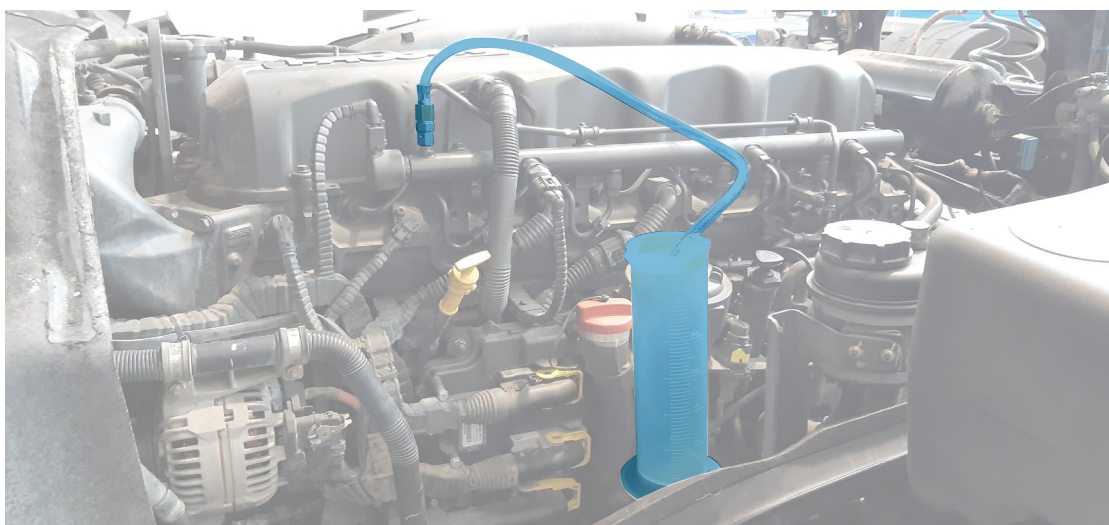

- Avvitare il tappo cieco “2” nell’estremità del tubo. Coppia di serraggio consigliata di 30 Nm.

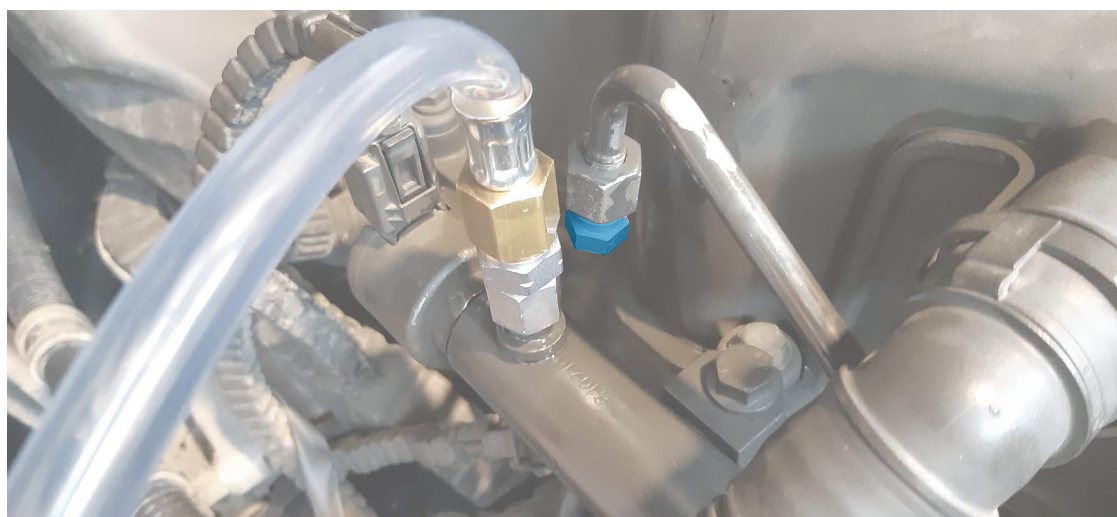

## 2.2 COLLEGAMENTO NEL RITORNO DEL COMBUSTIBILE DEGLI INIETTORI

- Liberare il tubo di ritorno del combustibile degli iniettori allentando il morsetto di sostegno e la vite cava del raccordo.

**Nota:** Raccogliere le rondelle a tenuta stagna.

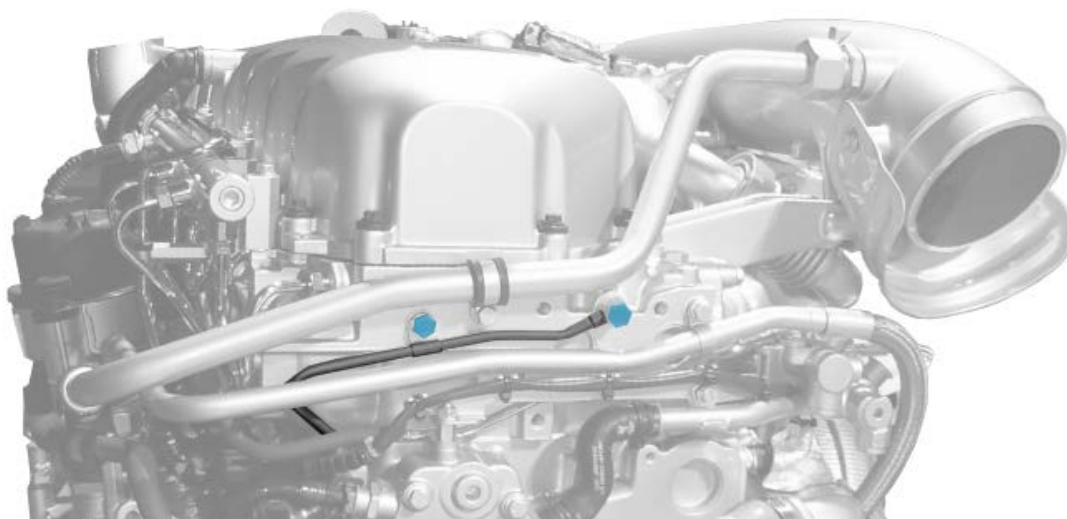

- Montare l'adattatore "4" con il raccordo invece della vite cava e usare le rondelle a tenuta stagna. Coppia di serraggio consigliata di 16 Nm.
- Collegare un'estremità del tubo di verifica "3" nell'adattatore "4". L'altra estremità del tubo deve essere inserita in un recipiente calibrato per la misurazione del volume.

**Nota :** il recipiente calibrato deve essere posizionato in modo tale che la sua altezza superi il punto di collegamento dell'adattatore.

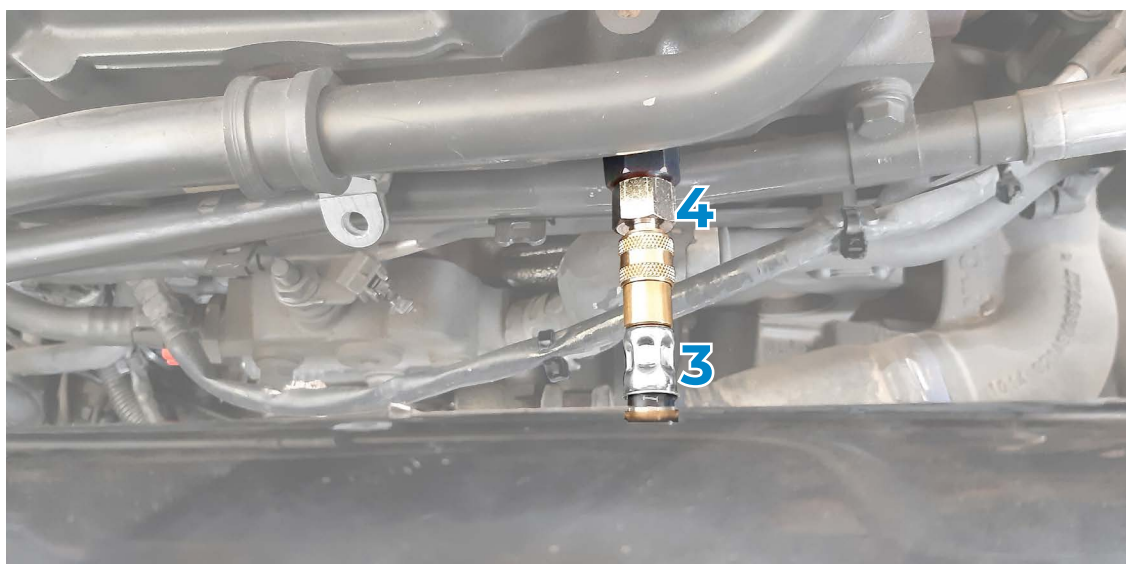

- 4 Adattatore
- 3 Estremità del tubo di verifica B

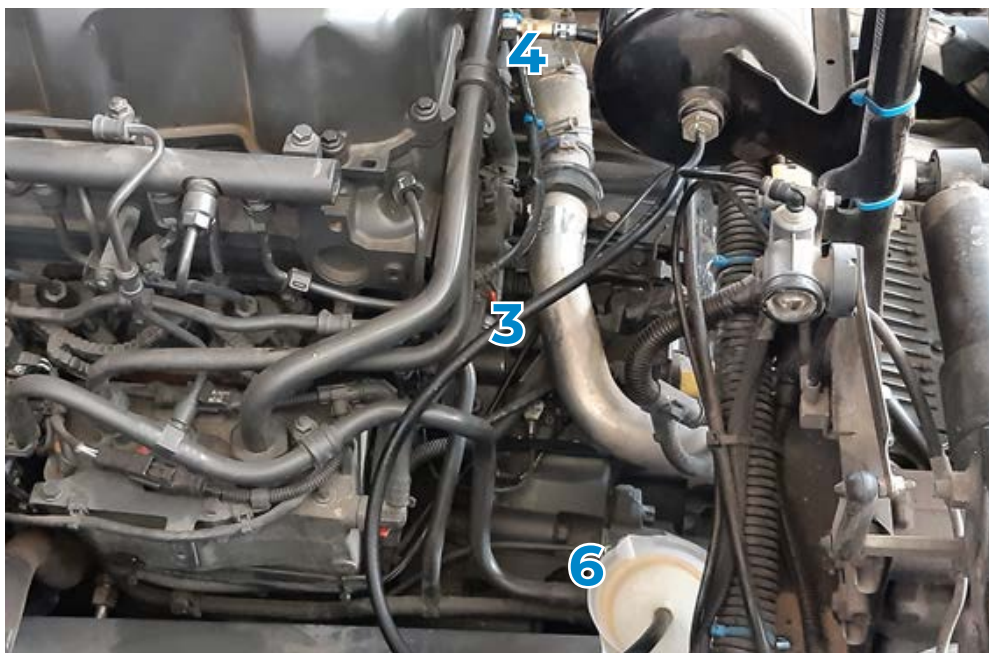

- 4 Adattatore
- 3 Tubo di verifica B
- 6 Recipiente calibrato

## 2.3 SPURGO DELL'IMPIANTO DEL COMBUSTIBILE

- Allentare la manopola della pompa manuale di alimentazione del combustibile ruotandola in senso antiorario.

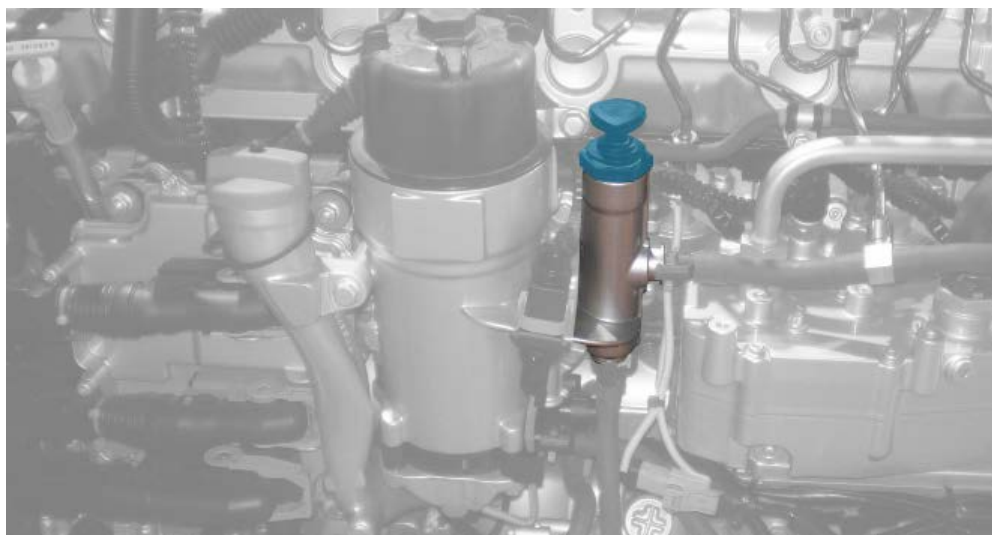

- Azionare la pompa fino alla pressurizzazione del circuito. Bisogna avvertire una resistenza al movimento.
- Serrare la manopola della pompa manuale di alimentazione del combustibile girandola verso destra.
- Mettere in moto il motore e mantenere il regime di minimo per alcuni minuti in modo da espellere l'aria dal circuito del combustibile.
- Raccogliere e smaltire il combustibile caduto nei recipienti calibrati.

## 3 Procedimento con lo strumento di diagnosi

- Eseguire la seguente verifica del sistema e prestare particolare attenzione alle informazioni aggiuntive fornite:

**Sistema PCI>>Verifiche del sistema>>"CIRCUITO AD ALTA PRESSIONE">>"UNITÀ DI POMPAGGIO"**

- Eseguire la seguente verifica del sistema e prestare particolare attenzione alle informazioni aggiuntive fornite:

**Sistema PCI>>Verifiche del sistema>>"CIRCUITO AD ALTA PRESSIONE">>"RITORNO DEL COMBUSTIBILE DEGLI INIETTORI"**

- **Note:** Usare l'otturatore per l'iniettore "5" se si desidera realizzare la prova con uno dei cilindri scollegati. Per farlo sarà necessario smontare il tubo dell'iniettore corrispondente e avvitare l'otturatore per l'iniettore "5" nel lato del rail. Coppia di serraggio consigliata:

- 1ère phase 15 Nm
- 2ème phase 30°

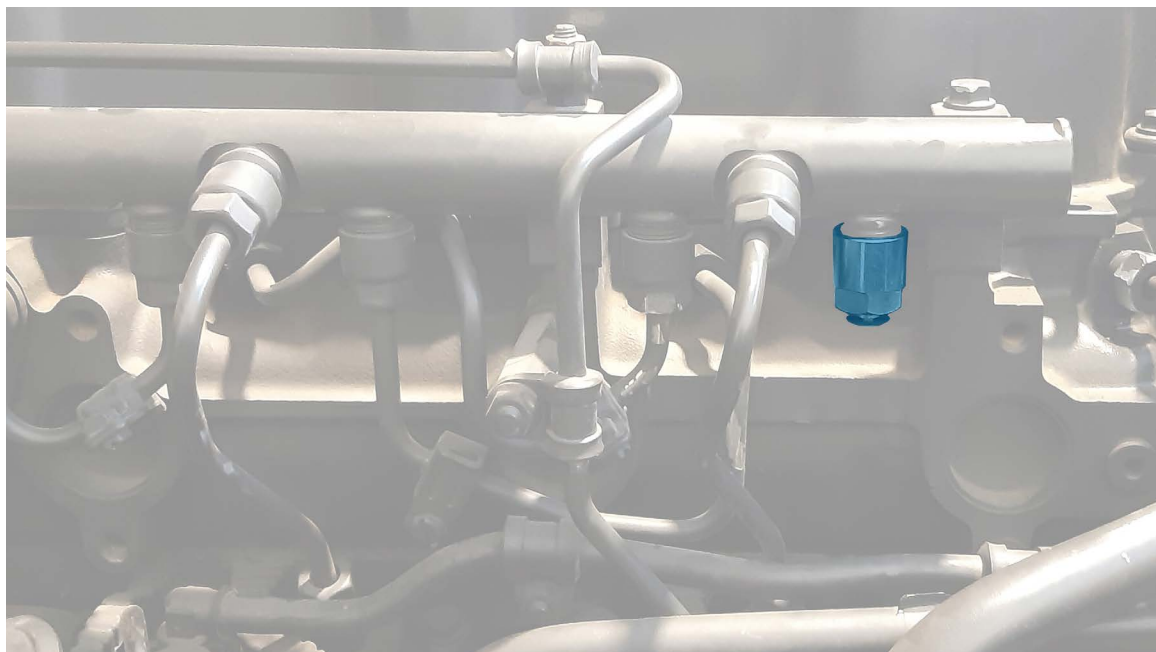



## 4 Passaggi successivi

- Drenare il combustibile dai tubi e smaltirlo insieme a quello dei recipienti.
- Smontare i componenti, pulire il combustibile colato e montare i componenti del veicolo tenendo in considerazione le coppie di serraggio consigliate:
  - Collegamento del tubo di rilascio della pressione del combustibile del rail: 30 Nm
  - Viti dei morsetti di sostegno: 30 Nm
  - Vite cava insieme al raccordo e alle rondelle a tenuta stagna: 16 Nm
- **Nota:** è consigliabile sostituire le rondelle a tenuta stagna.
- Tubi degli iniettori:
  - Lato della testata: 1ª fase 27 Nm e 2ª fase 30°
  - Lato del rail: 1ª fase 15 Nm e 2ª fase 30°
- Spurgare l'impianto del combustibile come indicato nel passaggio 2.3.
- Abbassare la cabina e chiudere la calandra.
- Eseguire una prova su strada e controllare che non ci siano perdite di combustibile.



## 5 Avvertenze e precauzioni

Precauzioni e avvertenze per lavorare con il combustibile:

- Evitare il contatto con gli occhi e la pelle, l'inalazione e l'ingestione.
- Evitare che si generino vapori, fuoriuscite e miscele con altri combustibili. Ciò può provocare una miscela esplosiva.
- Interrompere la prova se si rileva una perdita o qualsiasi altro pericolo.
- Mantenere la zona di lavoro ventilata e occupata solo dalle persone necessarie dotate dell'abbigliamento e degli accessori di protezione adeguati.
- Mantenere fuori dalla portata del combustibile possibili fonti di calore.
- Non toccare le guarnizioni dei componenti. Utilizzare guanti appropriati.



# ●.cojali

Jaltest.com  
cojali.com

2022 V.1 FR



Local Distributor



**Kit para verificação do circuito  
de alta pressão de combustível**

Manual do usuário

[jaltest.com](http://jaltest.com)

**cojali**

INNOVATION & TECHNOLOGY



Rev. 01



## Kit para verificação do circuito de alta pressão de combustível

Manual do usuário

**cojali**

INNOVATION & TECHNOLOGY



# Índice

Índice	3
Informação geral	4
Atuação de componentes	5
Procedimento com a ferramenta de diagnóstico	9
Passos seguintes	10
Avisos e Cuidados	11

## Navegação fácil

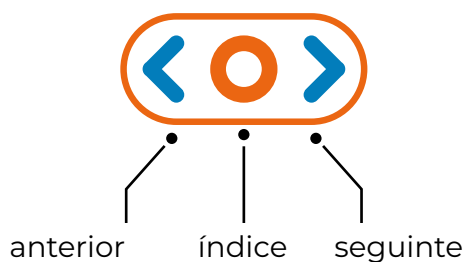

Acesse mais rápido ao conteúdo que precisa fazendo clique em

# 1 Informação geral

## 1.1 DESCRIÇÃO DO PRODUTO

É um conjunto de acessórios para realizar verificações de retorno de combustível dos injetores e da válvula de controle de pressão de combustível no trilho.

## 1.2 COMPOSIÇÃO DO EQUIPAMENTO

**1.** Mangueira de teste A. Para conexão com a válvula de controle de pressão de combustível no trilho.

**2.** Tampão cego. Para o tubo de combustível de retorno da válvula de controle de pressão do trilho.

**3.** Mangueira de teste B. Para ligação ao retorno de combustível dos injetores.

**4.** Adaptador. Para conexão no retorno de combustível dos injetores.

**5.** Obturador para injetor. Usado para cancelar um dos injetores.



## 1.3 APLICAÇÃO

Motores **MX13** de Paccar controlados pelo **sistema de gestão de motor PCI** e montados em diferentes marcas de diferentes tipos de veículos. Por exemplo:

- Implementos e equipamentos de colheita: VERVAET
- Autocarro/Ônibus: IRIZAR, OTOKAR, SOLARIS, TEMSA, VAN HOOL, VDL, YUTONG
- Camião: DAF, TATRA
- OHW: SPIERINGS
- Fabricantes: PACCAR

## 2 Atuação de componentes

**Atenção:** tome as devidas precauções ao realizar os trabalhos no sistema de combustível (consulte o ponto 4).

### 2.1 CONEXÃO EM TUBO DE DESCARGA DE PRESSÃO DE COMBUSTÍVEL

- Abra a grade e baixe a cabine.
- Solte os grampos de fixação e a porca do tubo de descarga de pressão do rail.



- Aperte a mangueira de teste “1” na conexão do tubo de descarga de combustível do trilho. Torque de aperto recomendado 30 Nm. A outra extremidade da mangueira deve ser inserida em um recipiente calibrado para medição de volume.

**Nota:** Evite dobrar o tubo.

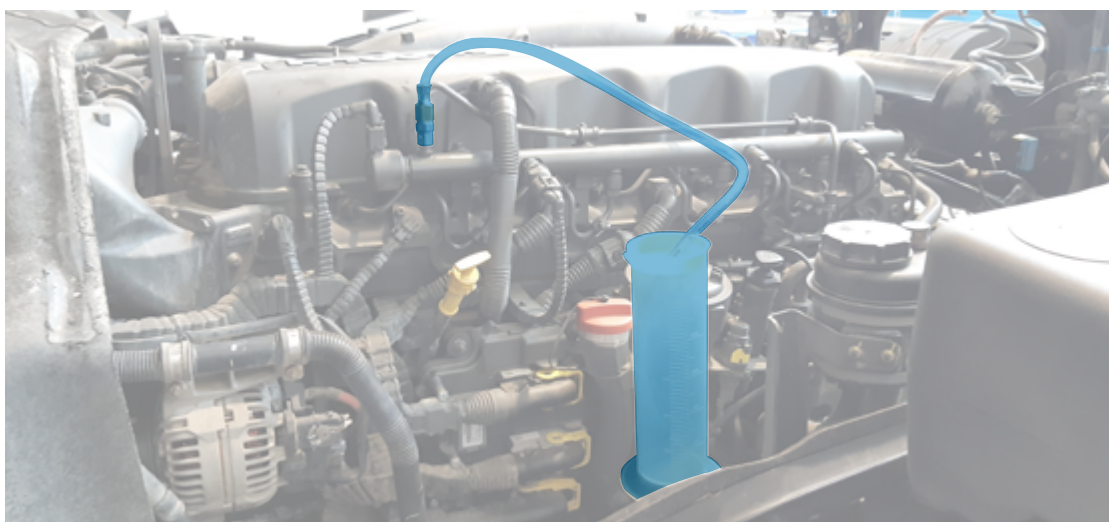

- Aperte o tampão cego “2” na extremidade do tubo. Torque de aperto recomendado 30 Nm.



## 2.2 CONEXÃO DE RETORNO DE COMBUSTÍVEL DOS INJETORES

- Solte o tubo de retorno de combustível dos injetores afrouxando a braçadeira de fixação e o parafuso oco do encaixe.

**Nota:** recolher as arruelas de estanquidade.

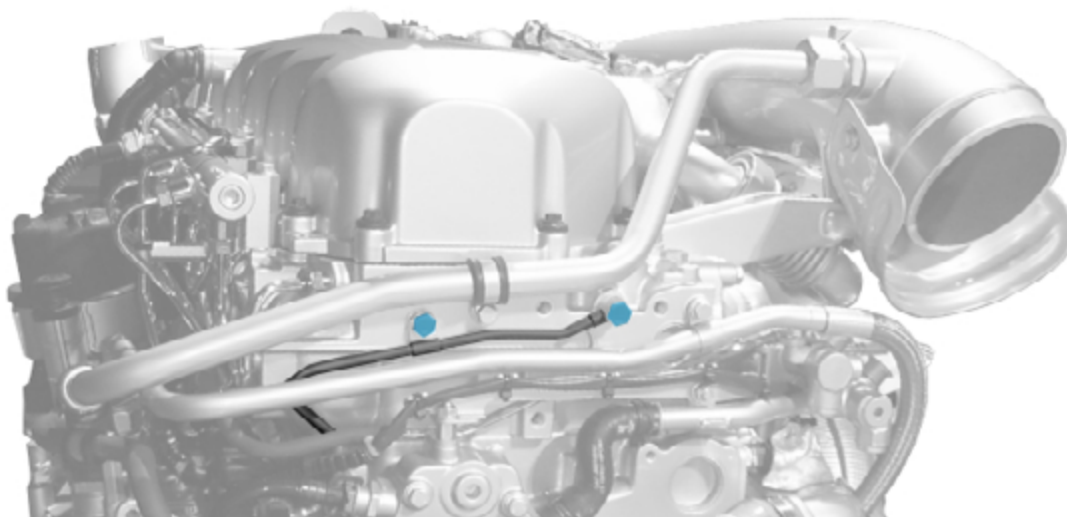

- Instale o adaptador “4” com o encaixe ao invés do parafuso oco e utilize as arruelas de estanquidade. Torque de aperto recomendado 16 Nm.
- Conecte uma extremidade da mangueira de teste “3” ao adaptador “4”. A outra extremidade da mangueira deve ser inserida em um recipiente calibrado para medição de volume.

**Nota :** O recipiente calibrado deve ser posicionado de forma que a sua altura seja superior ao ponto de conexão do adaptador.

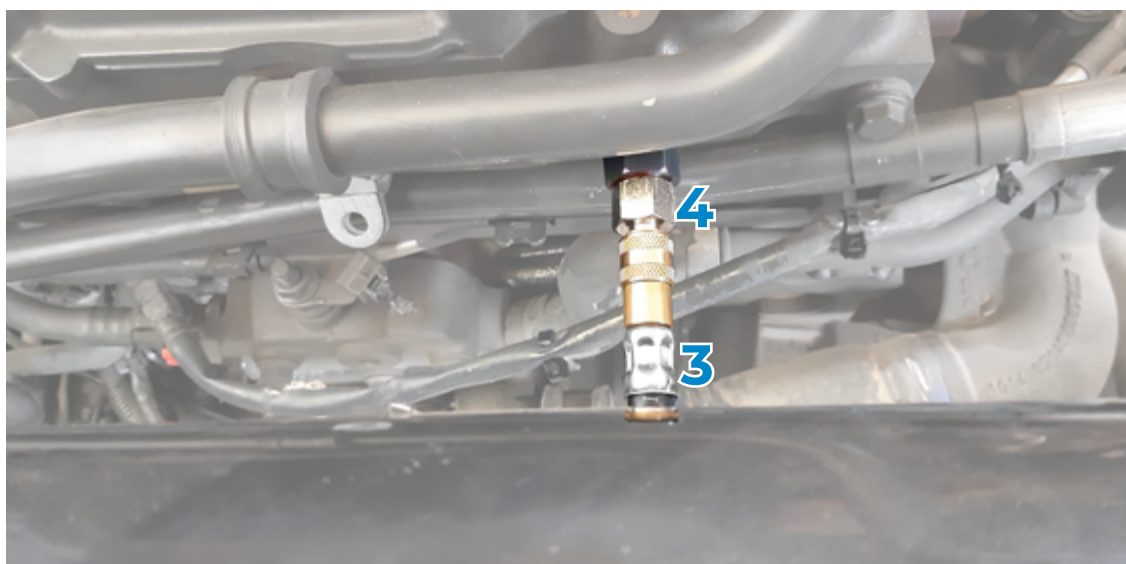

- 4 Adaptador
- 3 Extremidade da mangueira de teste B



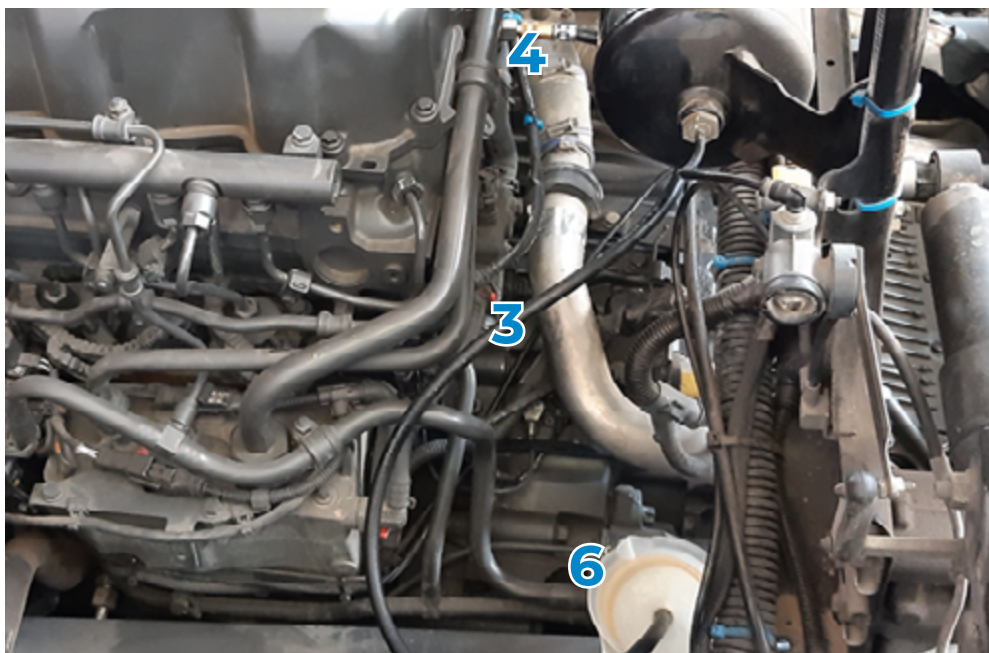

- 4 Adaptador
- 3 Mangueira de teste B
- 6 Recipiente calibrado

## 2.3 PURGAR O SISTEMA DE COMBUSTÍVEL

- Afrouxe o controle da bomba de alimentação manual de combustível girando-o no sentido anti-horário.

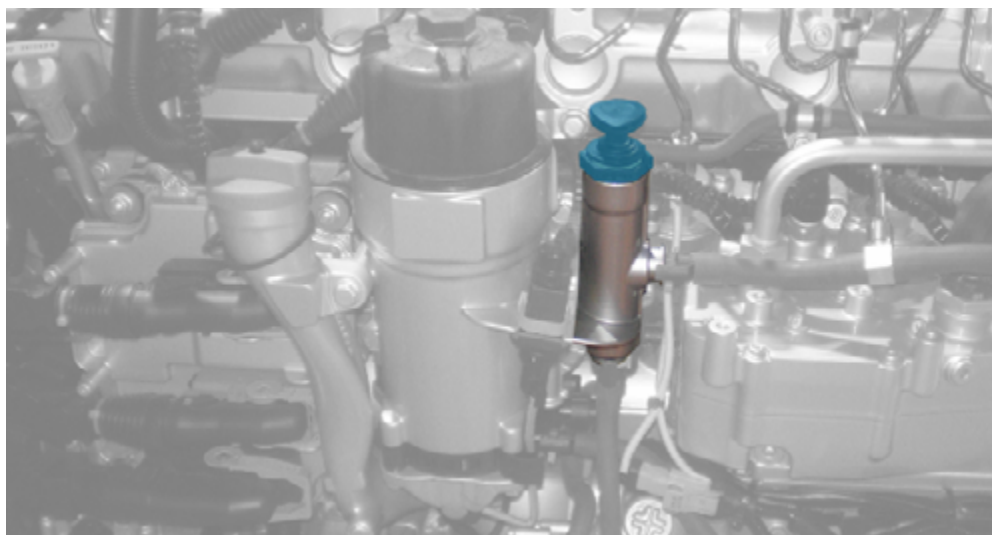

- Acionar a bomba até pressurizar o circuito e se observe resistência ao movimento.
- Aperte o botão da bomba de alimentação manual de combustível girando-o para a direita.
- Ligue o motor e deixe-o em ralenti por alguns minutos para expelir o ar do circuito de combustível.
- Recolha e descarte qualquer combustível que possa ter caído nos recipientes calibrados.



## 3 Procedimento com a ferramenta de diagnóstico

- Realize a seguinte verificação do sistema e preste atenção às informações adicionais fornecidas:

**Sistema PCI>>Verificações do sistema>>“CIRCUITO DE ALTA PRESSÃO”>>“UNIDADE DE BOMBAGEM”**

- Realize a seguinte verificação do sistema e preste atenção às informações adicionais fornecidas:

**Sistema PCI>>Verificações do sistema>>“CIRCUITO DE ALTA PRESSÃO”>>“RETORNO DE COMBUSTÍVEL DOS INJETORES”**

**Nota:** utilize o obturador para o injetor “5” se desejar realizar o teste com um dos cilindros desconectado. Para isso, será necessário desmontar o tubo do injetor correspondente e apertar o obturador para o injetor “5” na lateral do trilho. Torque de aperto recomendado:

- 1ª fase 15 Nm
- 2ª fase 30°





## 4 Passos seguintes

- Drene o combustível das mangueiras e descarte-o junto com o combustível dos recipientes.
- Desinstalar os componentes, limpar o combustível derramado e montar os componentes do veículo respeitando os torques de aperto recomendados:
  - Conexão do tubo de descarga de pressão de combustível do trilho: 30Nm
  - Parafusos das braçadeiras de fixação: 30 Nm
  - Parafuso oco juntamente com encaixe e arruelas de estanquidade: 16 Nm
- **Nota:** Recomenda-se substituir as arruelas de estanquidade.
- Tubos dos injetores:
  - Lado da cabeça do cilindro: 1ª fase 27 Nm e 2ª fase 30°
  - Lado do trilho: 1ª fase 15 Nm e 2ª fase 30°
- Purgar o sistema de combustível conforme indicado no passo 2.3.
- Baixe a cabina e feche a grelha.
- Faça um teste de estrada e verifique se não há vazamentos de combustível.



## 5 Avisos e Cuidados

Precauções e advertências para trabalhar com combustível:

- Evite contato com os olhos e pele, inalação e ingestão.
- Evite a geração de vapores, derramamentos e misturas com outros combustíveis. Isso pode ser uma mistura explosiva.
- Interrompa o teste se for detectado um vazamento ou qualquer outro perigo potencial.
- Mantenha a área de trabalho ventilada e somente com as pessoas necessárias devidamente uniformizadas com roupas e acessórios de proteção.
- Mantenha todas as possíveis fontes de ignição longe do combustível.
- Não toque nas juntas dos componentes. Use luvas apropriadas.

# ●.cojali

Jaltest.com  
cojali.com

2022 V.1 PT



Local Distributor