

1

2

3

4

A Technical sheet / Datos técnicos:

Part number adaptable to / Referencia adaptable a	92796S
Voltage / Tensión	24V
Current / Intensidad	0.5A
Permissible medium / Medio de funcionamiento	Air / Aire
Operating temperature range / Rango de temperatura	-40 °C to / a +80 °C
Weight / Peso	1750 gr

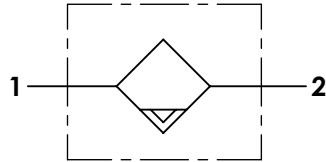

Port / Conexión	Function / Función	Thread / Rosca
1	Supply / Alimentación	M22x1.5
2	Delivery / Salida	M22x1.5
3	Exhaust / Escape	-
6	Connector / Conector	M24x1

Purpose / Propósito: Eliminating oil particles, liquids and other contaminants that can arrive through the compressor in order to avoid they reach the air system. / Eliminar partículas de aceite, líquidos y otros contaminantes que pueden llegar a través del compresor con el fin de evitar que estos alcancen el sistema de aire.

Installation requirements / Requisitos para la instalación: The air condenser is installed between compressor and air dryer. / El condensador de aire se instala entre el compresor y el secador de aire.

Modification	4				Drawn		
	3				28/07/20 S.F.		
	2				Checked		
	1				28/07/20 O.V.		
	nº	Modified	Date	Reason	General Tolerance		Assembly
Comments					-	Part name	Air condenser
					Material	ID. Reference	2480005
					-	Scale: -	
					-	Review: 0	

1

2

3

4

A

A

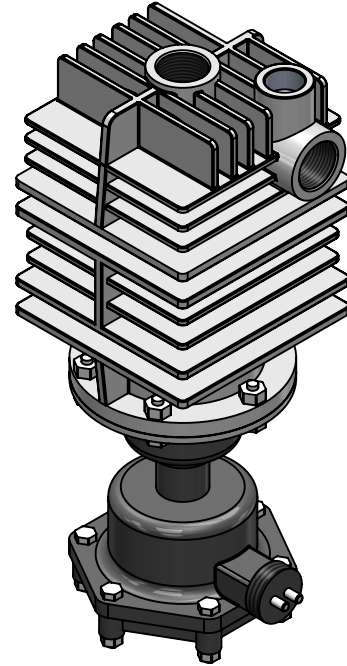
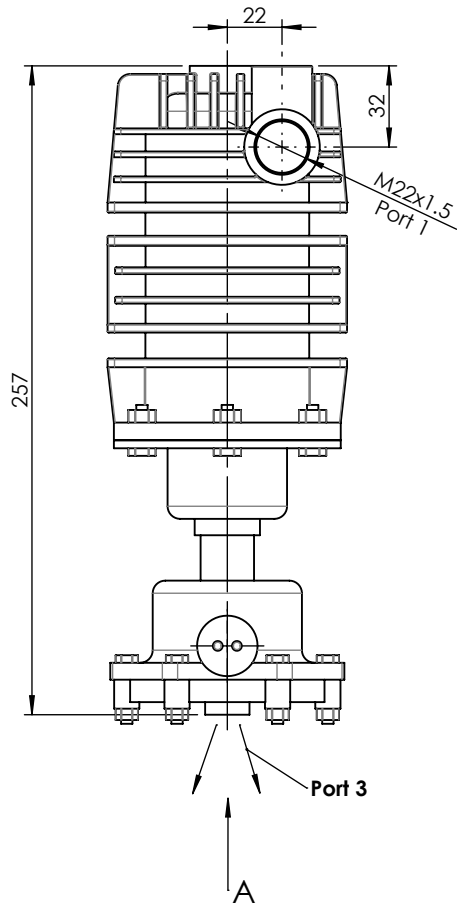

B

B

C

C

D

D

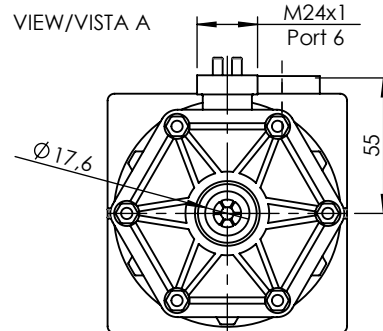
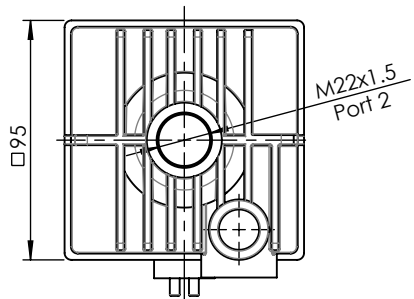

E

E

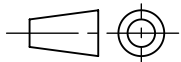
F	Modification	4				Drawn		F
		3				28/07/20 S.F.		
		2				Checked		
		1				28/07/20 O.V.		
		nº	Modified	Date	Reason	General Tolerance		
Comments					ISO 2768 c-K	Part name	Air condenser	
					Material	ID. Reference	2480005	
					-	Scale: 1/3		Sheet 2/2
					-	Review: 0		