

1

2

3

4

A

Technical sheet / Datos técnicos:

Part number adaptable to / Referencia adaptable a	4341002210
Working pressure / Presión de trabajo	max. 13 bar
Type / Tipo	With limited return flow / Con retorno del flujo limitado
Opening pressure / Presión de apertura	5 bar
Permissible medium / Medio de funcionamiento	Air / Aire
Operating temperature range / Rango de temperatura	-40 °C to / a +80 °C
Weight / Peso	420 gr

A

B

B

C

C

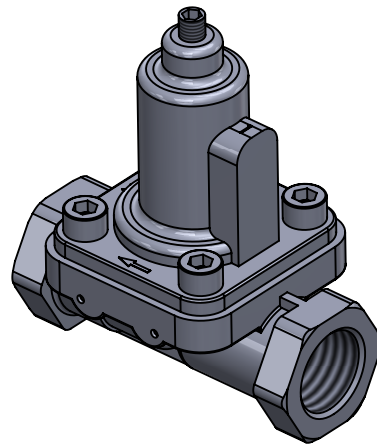
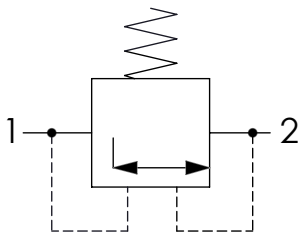

D

D

Port / Conexión	Function / Función	Thread / Rosca
1	Supply / Alimentación	M22x1.5
2	Delivery / Salida	M22x1.5

Purpose / Propósito: Allow air flow to a second air compressed reservoir if a certain regulated pressure is reached in the first reservoir. This is useful to give priority to the filling of air from one circuit over another one (for example: priority of filling brake circuit instead of suspension circuit) / Permitir el paso de aire hacia un segundo depósito de aire comprimido si en el primer depósito se alcanza una determinada presión regulada en la válvula. Esto sirve para priorizar el llenado de aire de un circuito frente a otro (por ejemplo: prioridad de llenado de circuito de frenos frente a circuito de suspensión)

E

E

Installation requirements / Requisitos para la instalación: To install the valve directly into the air reservoir inlet using the appropriate connection. / Instalar la válvula directamente en la entrada del depósito de aire usando la conexión oportuna.

F

F

Modification	4				Drawn		
	3				17/02/11 A.U.		
	2				Checked		
	1				17/02/11 A.L.		
nº	Modified	Date	Reason	General Tolerance	Assembly	-	
Comments					-	Part name	Charging valve
					Material	ID. Reference	2206156
					-	Scale: -	
					-	Review: 0	

1

2

3

4

A

A

B

B

C

C

D

D

E

E

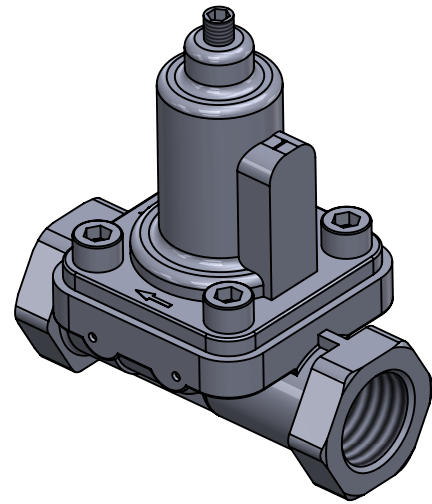
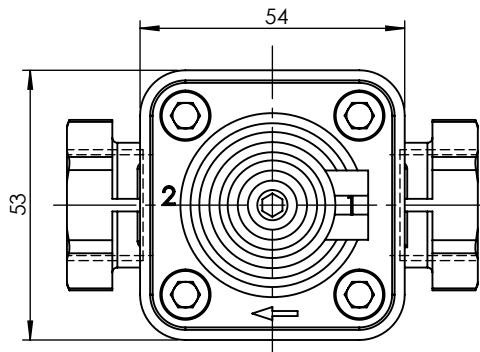
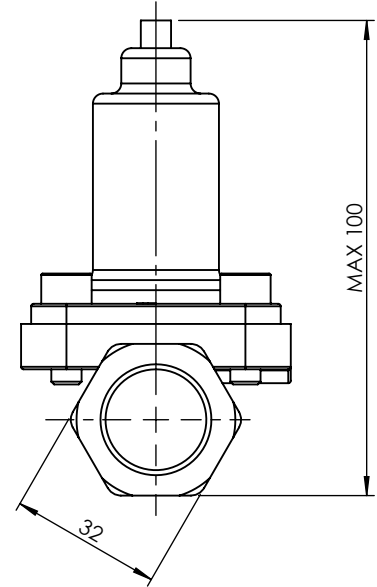
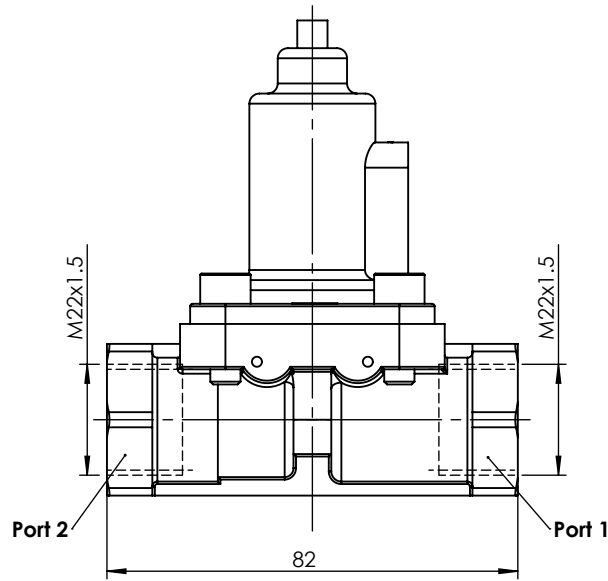

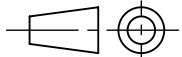
F	Modification	4				Drawn		F
		3				17/02/11 A.U.		
		2				Checked		
		1				17/02/11 A.L.		
	nº	Modified	Date	Reason	General Tolerance	Assembly		
Comments					ISO 2768 c-K	Part name	Charging valve	
					Material	ID. Reference	2206156	
					-	Scale: 2/3		Sheet 2/2
					-	Review: 0		