

Technical Sheet / Datos Técnicos:

Part number adaptable to / Referencia adaptable a:	LA 8298
Safety valve pressure / Presión válvula de seguridad:	13.5 bar
Unloader / Regulador de presión:	Integrated / Integrado
Cut-out pressure / Presión de corte:	10±0.3 bar
Heating / Calentador:	100W / 24 V
Permissible Medium / Medio de funcionamiento:	Air / Aire
Operating temperature range / Rango de temperatura:	- 40°C a / to +80°C
Cut-in temperature / Temperatura de cierre:	+7°± 6°C
Cut-off temperature / Ajuste de la temperatura:	+29.5°± 4°C
Weight / Peso:	2231 gr

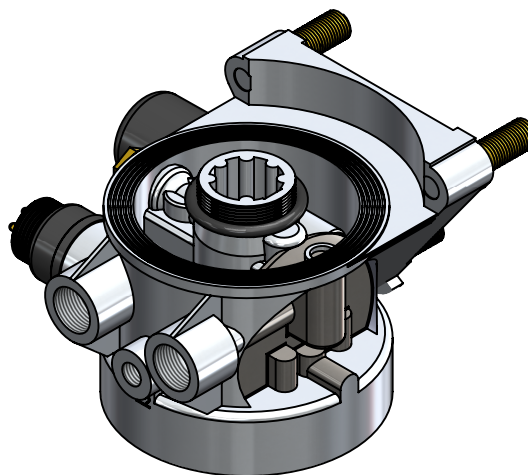

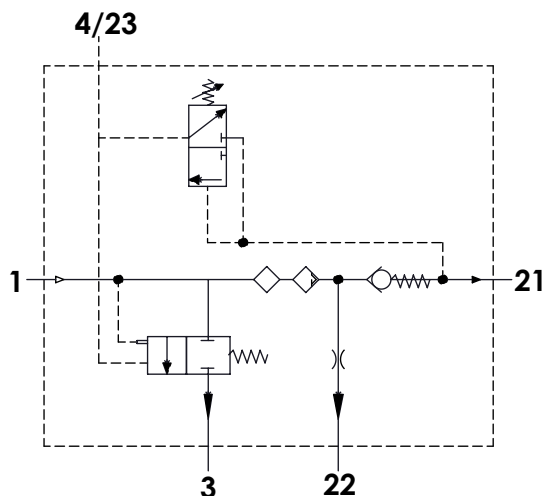

Port / Conexión	Function / Función	Thread / Rosca
1	From the compressor / Proveniente del compresor	M22x1,5
21	To the reservoirs / A los calderines	M22x1,5
22	To the regenerated air reservoir / Al calderín de regeneración	M12x1,5
4/23	Control port / Puerto de control	M12x1,5
3	Exhaust for compressed air / Escape de aire comprimido	-
6	Heating / Calentador	M27x1

Purpose / Finalidad: Drying of the compressed air supplied by the compressor. /
Secado del aire comprimido procedente del compresor.

Installation / Instalación: Exhaust (3) must look down. /
El escape de aire (3) debe estar orientado hacia abajo.

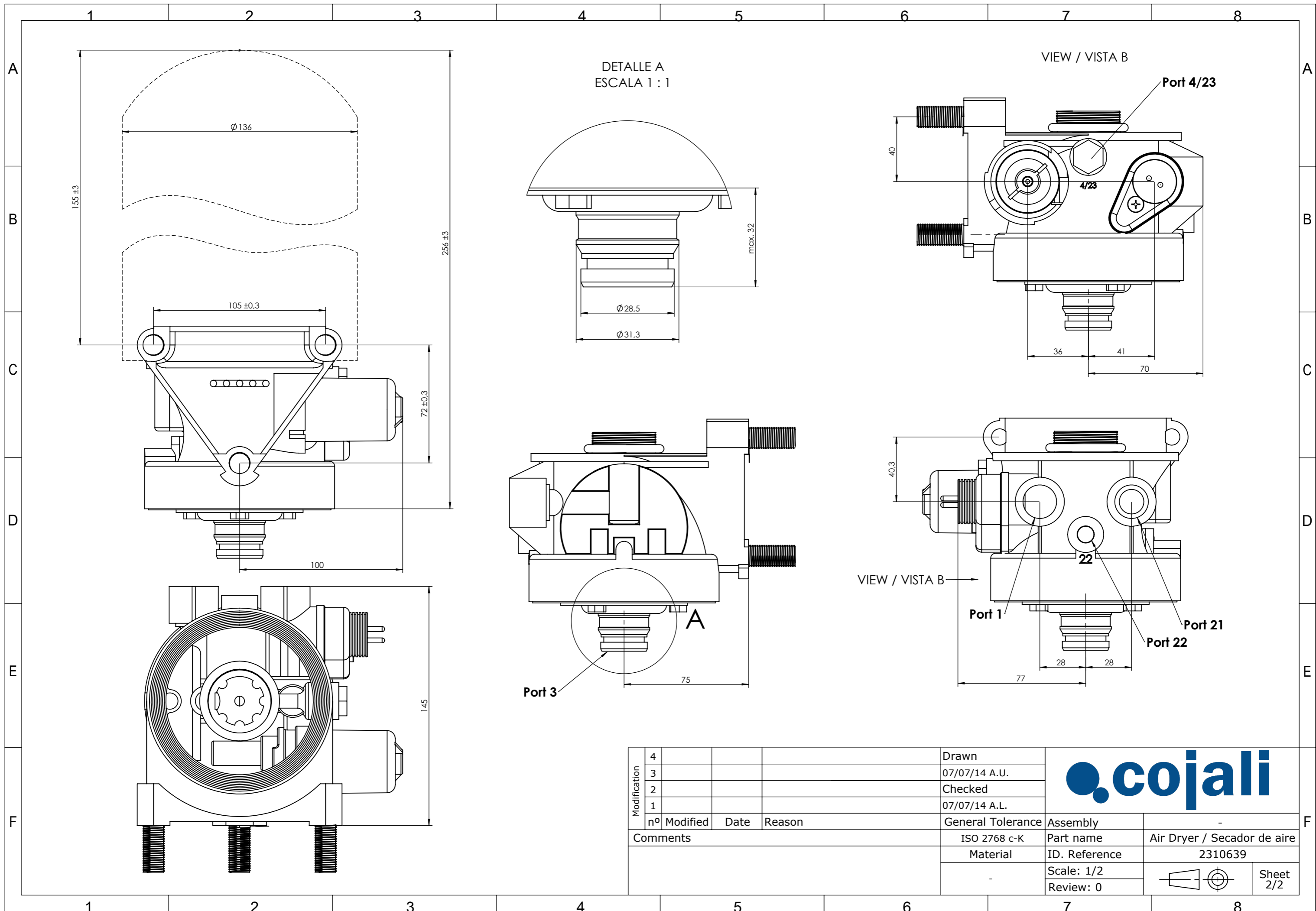
Modification	4				Drawn		
	3				07/07/14 A.U.		
	2				Checked		
	1				07/07/14 A.L.		
	nº	Modified	Date	Reason	General Tolerance		Assembly
Comments					-	Part name	Air Dryer / Secador de aire
					Material	ID. Reference	2310639
					-	Scale: -	
					-	Review: 0	

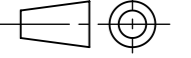

Modification	4			Drawn		
	3			07/07/14 A.U.		
	2			Checked		
	1			07/07/14 A.L.		
	nº Modified	Date	Reason	General Tolerance	Assembly	
Comments				ISO 2768 c-K	Part name	-
				Material	ID. Reference	Air Dryer / Secador de aire
					Scale: 1/2	2310639
					Review: 0	
						Sheet 2/2