

A Technical sheet / Datos técnicos:

Part number adaptable to / Referencia adaptable a	4613190320
Operating pressure / Presión de trabajo	max. 10 bar
Predominance / Predominancia	≤ 0,3 bar
Permissible medium / Medio de funcionamiento	Air / Aire
Operating temperature range / Rango de temperatura	-40°C to / a +80°C
Weight / Peso	1400 gr

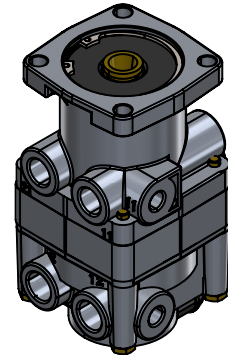
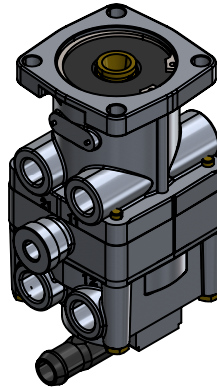
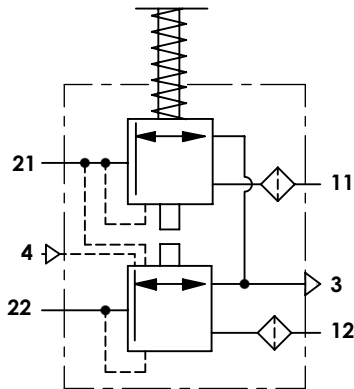

Port / Conexión	Function / Función	Thread / Rosca
11	Supply / Alimentación	2x M16x1,5
12	Supply / Alimentación	2x M16x1,5
4	Control / Pilotaje	M12x1,5
21	Delivery / Salida	2x M16x1,5
22	Delivery / Salida	2x M16x1,5
3	Exhaust / Escape	Tube / Tubo 90°

Purpose / Propósito:

Application of service brake system through the pedal actuation by the driver. / Aplicación del freno de servicio mediante la actuación del pedal por parte del conductor.

Installation requirements / Requisitos para la instalación:

The design of the foot brake valve, acting on seat, must guarantee the maximum way of the push rod that is necessary to control the valve even in case of failure in the circuit I. Mounting is accomplished with four screws M8. / El diseño de la válvula de freno de pie, accionándolo desde el asiento, debe garantizar el máximo recorrido de la varilla de empuje que resulta necesario para el accionamiento de la válvula, incluso en caso de que falle el circuito I. El montaje se efectúa con cuatro tornillos M8.

F	Modification	4				Drawn	
		3				12/08/15 A.U.	
		2				Checked	
		1				12/08/15 A.L.	
		nº	Modified	Date	Reason	General Tolerance	
Comments					-	Part name	Foot brake valve
					Material	ID. Reference	2212508
					-	Scale: -	
					-	Review: 0	

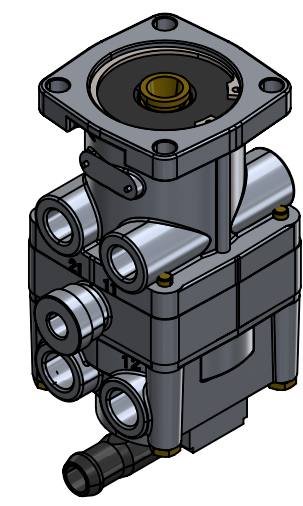
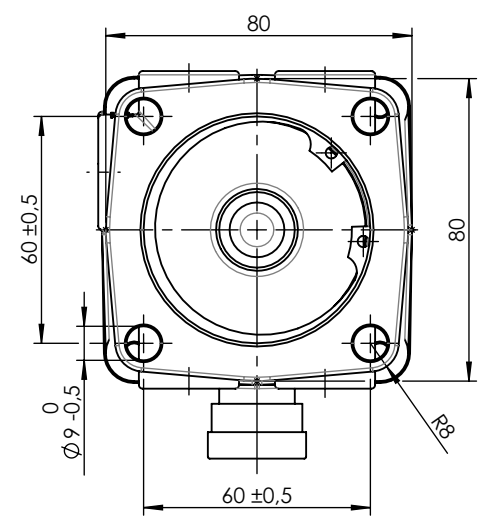
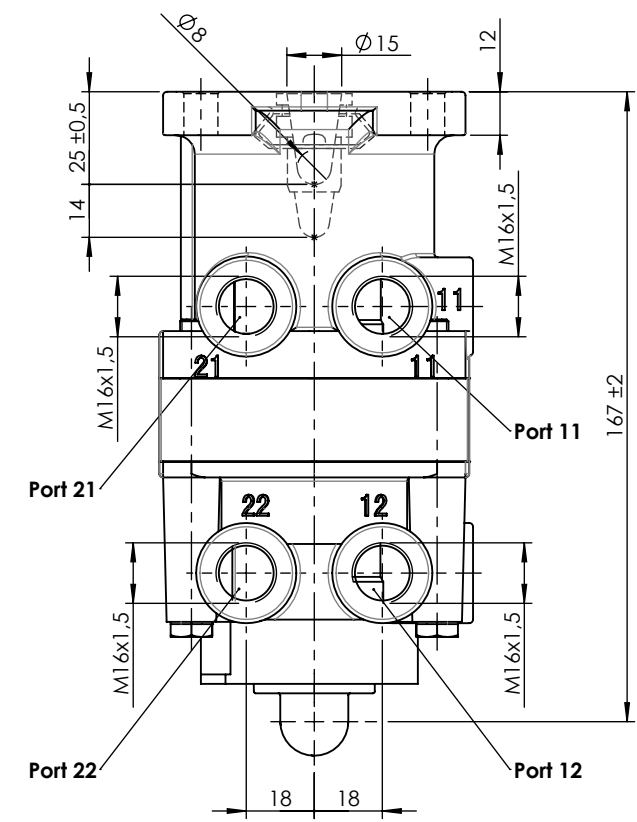
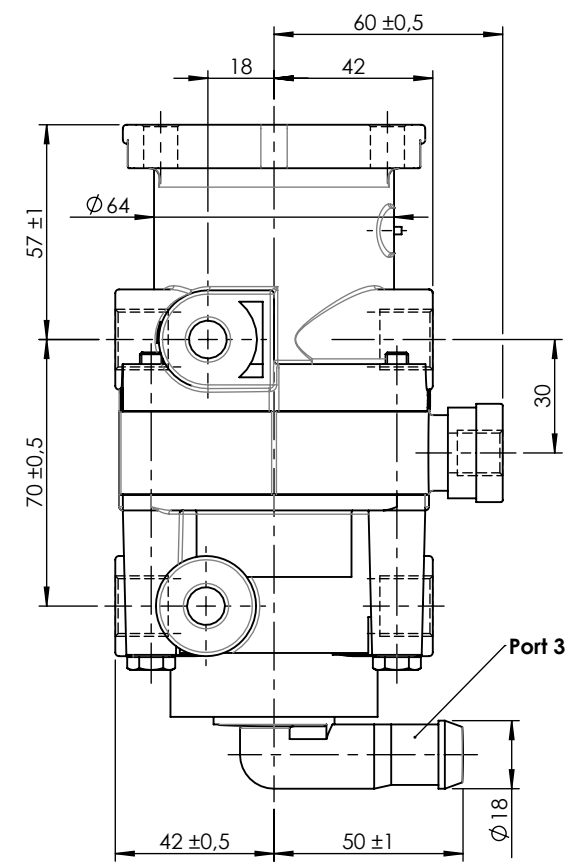
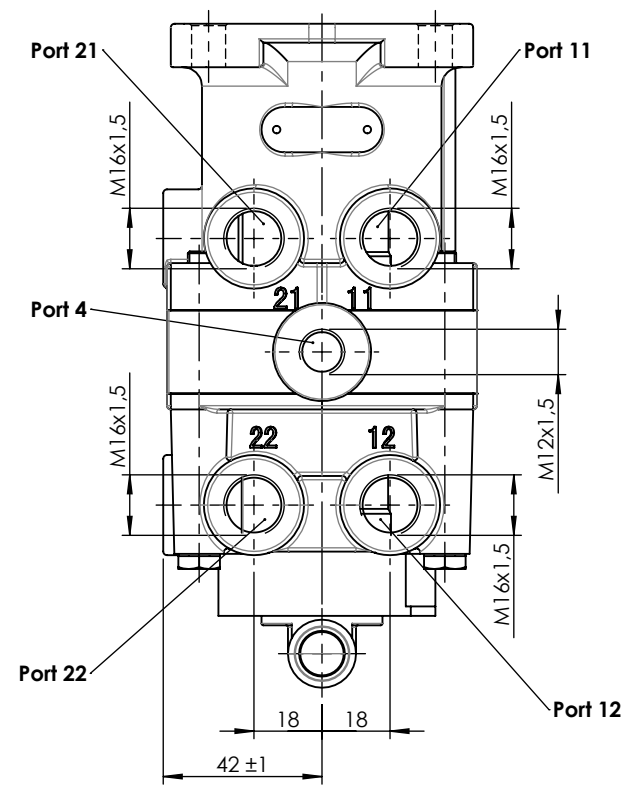

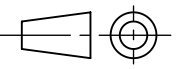
Modification	4			Drawn		
	3			12/08/15 A.U.		
	2			Checked		
	1			12/08/15 A.L.		
	nº Modified	Date	Reason	General Tolerance	Assembly	-
Comments				ISO 2768 c-K	Part name	Foot brake valve
				Material	ID. Reference	2212508
					Scale: 1/2	
					Review: 0	