

Technical sheet / Datos técnicos:

Part number adaptable to / Referencia adaptable a	DR3563
Opening pressure of safety valve / Presión de apertura válvula de seguridad	15 bar
Cut-out pressure / Presión de corte	8,1 bar
Permissible medium / Medio de funcionamiento	Air / Aire
Operating temperature range / Rango de temperatura	-40°C to / a +100°C
Weight / Peso	550 gr

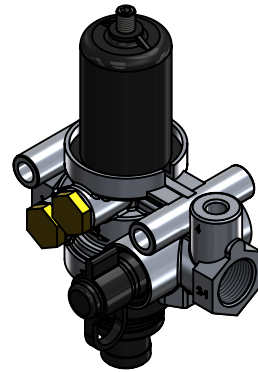
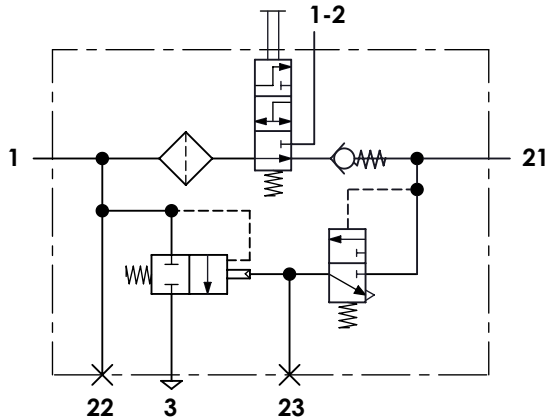

Port / Conexión	Function / Función	Thread / Rosca
1	Supply from air compressor / Alimentación desde el compresor	M22x1,5
1-2	Tire inflation device / Dispositivo de inflado de neumáticos	M16x1,5
21	Delivery to air dryer / Salida al secador	M22x1,5
22	Auxiliary supply / Alimentación auxiliar	Closed / Taponada
23	Control to air dryer / Pilotaje al secador	Closed / Taponada
3	Exhaust / Escape	-

Purpose / Propósito:

Regulation of air pressure in the air reservoirs. When air reservoirs reach enough pressure, send a signal to the air dryer to start with the regeneration phase and the filter cleaning./

Regulación de la presión de aire en los depósitos de aire comprimido. Cuando los depósitos de aire comprimido tienen una presión suficiente, manda una señal a la válvula secadora para empezar con la etapa de regeneración y limpieza del filtro.

Installation requirements / Requisitos para la instalación:

The unloader valve should be installed so that the exhaust port points downwards. Mounting is accomplished with two M8 screws. / El regulador debe instalarse de forma que el escape quede orientado hacia abajo. El montaje se realiza con dos tornillos M8.

Modification	4				Drawn		
	3				18/09/14 A.U.		
	2				Checked		
	1				18/09/14 A.L.		
	nº	Modified	Date	Reason	General Tolerance		Assembly
Comments					-	Part name	Unloader valve
					Material	ID. Reference	2328510
					-	Scale: -	
					-	Review: 0	

1 2 3 4

A

A

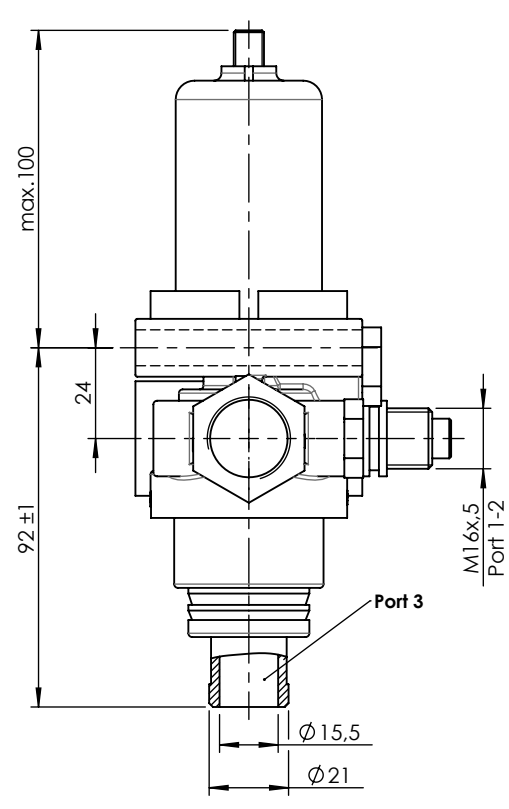
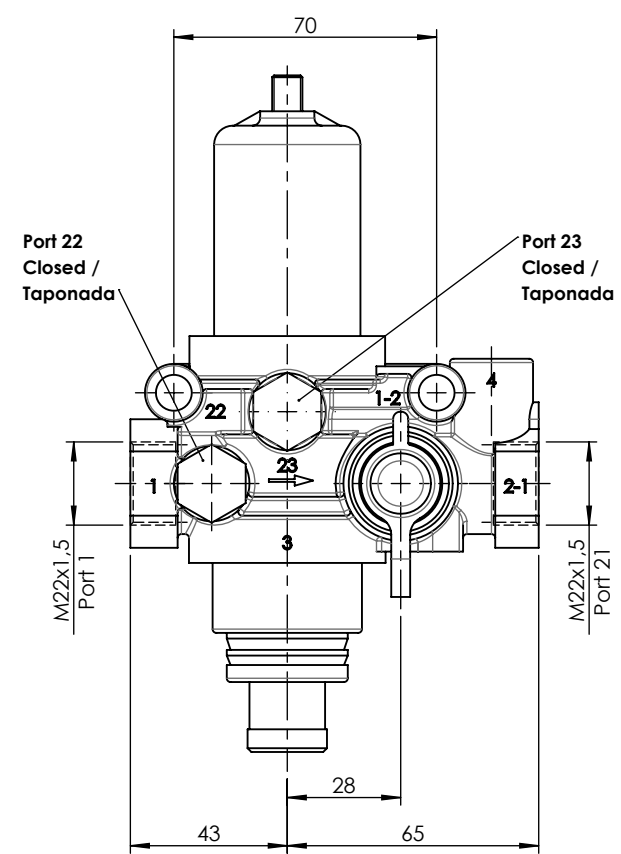

B

B

C

C

D

D

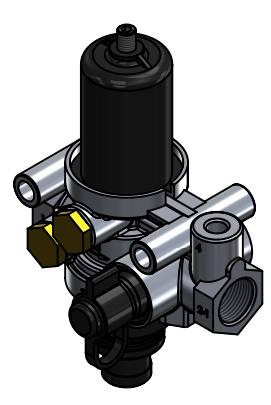
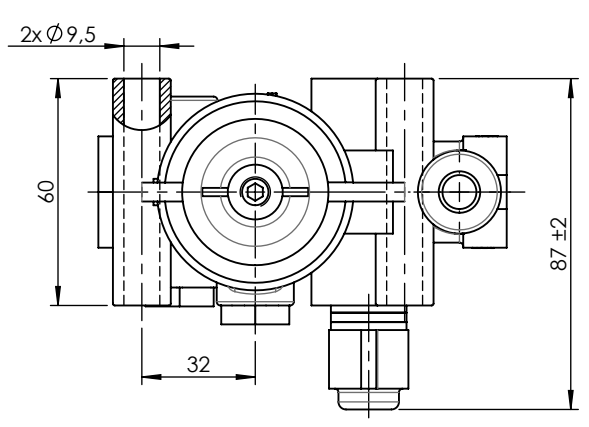

E

E

F	Modification	4				Drawn		F
		3				18/09/14 A.U.		
		2				Checked		
		1				18/09/14 A.L.		
		nº	Modified	Date	Reason	General Tolerance		
Comments					ISO 2768 c-K	Part name	Unloader valve	
					Material	ID. Reference	2328510	
					-	Scale: 1/2		Sheet 2/2
					-	Review: 0		