

Technical data/ Datos técnicos:

According to / En referencia a:	3172171
Operating temperature range/Rango de temperatura:	-40°C a/to 80°C
Supply voltage/Voltaje:	24V DC ±5%
Weight/Peso:	365 gr

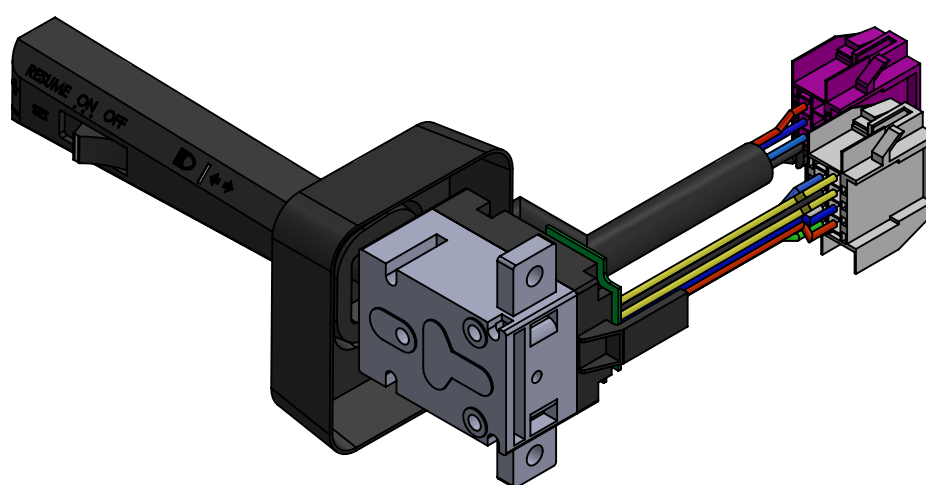

Purpose / Propósito: Activate the turn signals of the vehicle, main beam flash, ON/OFF key, +/- key and RESUME key/ Permite activar los intermitentes del vehículo, hacer ráfagas, activar las teclas ON/OFF, +/- y RESUME.

Installation Requirements / Requisitos para la instalación: fix the switch in the steering column housing, using the 2 holes located in the body of the switch / Ubicar el interruptor en el alojamiento de la columna de dirección, utilizando los 2 anclajes situados en el cuerpo del mismo.

Modification	4				Drawn		
	3				22/09/20 S.F.		
	2				Checked		
	1				22/09/20 E.L.		
F	nº	Modified	Date	Reason	General Tolerance	Assembly	-
	Comments				ISO 2768 c-K	Part name	Combination Switch/Interruptor de columna
					Material	ID. Reference	2260208
					-	Scale: -	
					Review: 0	Sheet 1/2	

1

2

3

4

A

A

5 PIN CONNECTOR

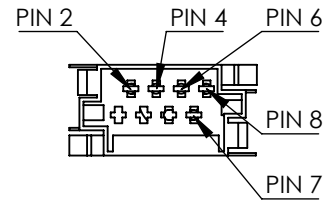

5 PIN CONNECTOR

8 PIN CONNECTOR

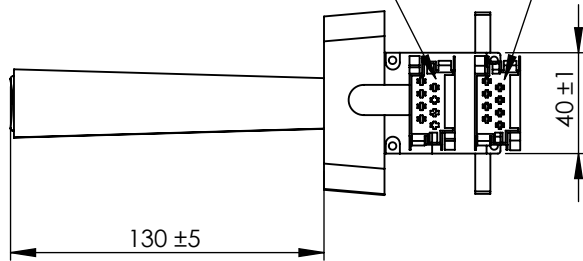

B

8 PIN CONNECTOR

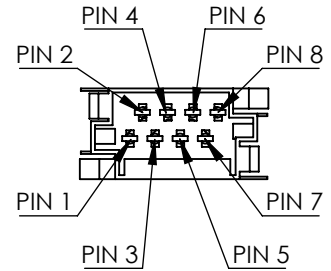

C

C

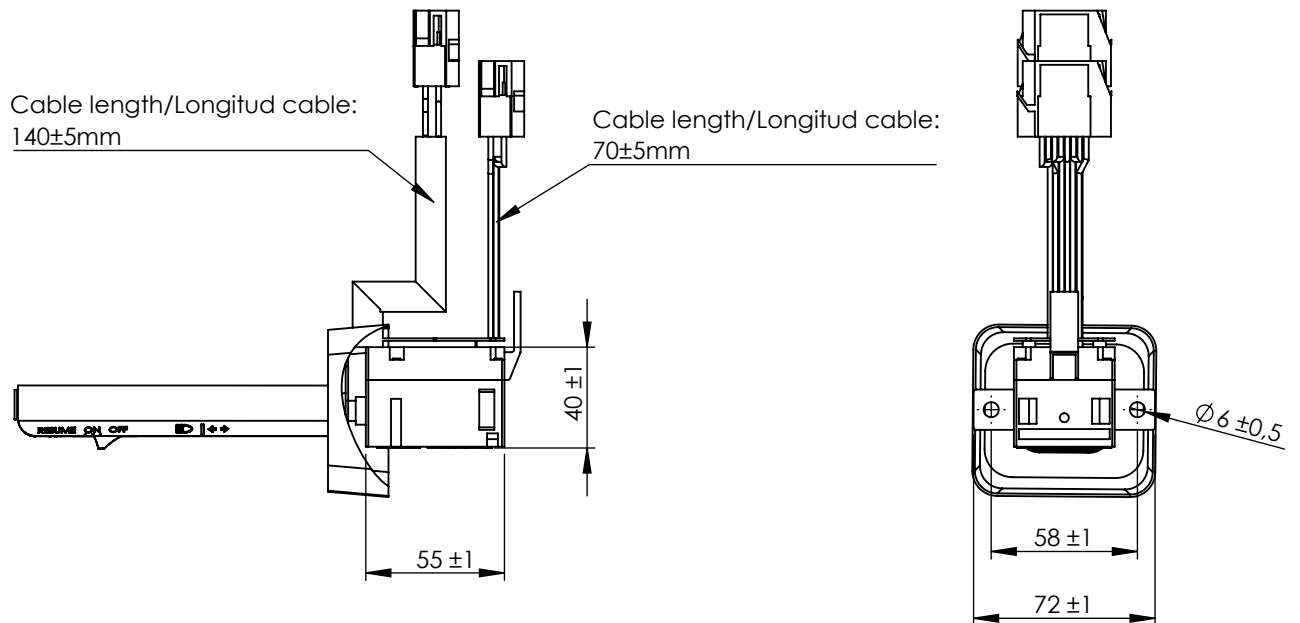

D

E

E

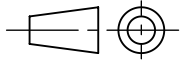
F	Modification	4				Drawn		F
		3				22/09/20 S.F.		
		2				Checked		
		1				22/09/20 E.L.		
	nº	Modified	Date	Reason	General Tolerance	Assembly		
Comments					ISO 2768 c-K	Part name	Combination Switch/Interruptor de columna	
					Material	ID. Reference	2260208	
					-	Scale: 1/3		Sheet 2/2
					-	Review: 0		