

Technical Sheet / Datos Técnicos:

Part number adaptable to / Referencia adaptable a:	432 410 008 0
Working pressure / Presión de trabajo:	Max = 13 bar
Unloader / Regulador de presión:	Integrated / Integrado
Cut-out pressure / Presión de corte:	11.8±0.3 bar
Heating / Calentador:	100W / 24 V
Permissible Medium / Medio de funcionamiento:	Air / Aire
Operating temperature range / Rango de temperatura:	- 40°C a / to +80°C
Cut-in temperature / Temperatura de cierre:	+7° ± 6°C
Cut-off temperature / Ajuste de la temperatura:	+29.5° ± 3°C
Weight / Peso:	1540 gr

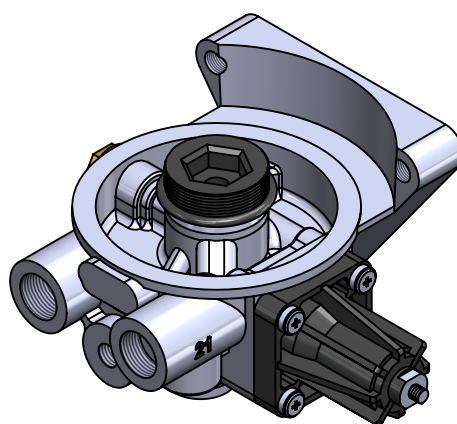
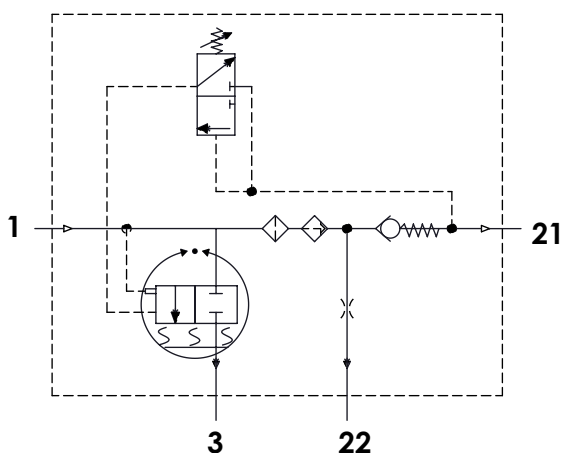

Port / Conexión	Function / Función	Thread / Rosca
1	From the compressor / Proveniente del compresor	M22x1,5
21	To the reservoirs / A los calderines	M22x1,5
22	To the regenerated air reservoir / Al calderín de regeneración	M12x1,5
3	Exhaust for compressed air / Escape de aire comprimido	-
6	Heating / Calentador	M27x1

Purpose / Finalidad: Drying of the compressed air supplied by the compressor. / Secado del aire comprimido procedente del compresor.

Installation / Instalación: Exhaust (3) must look down. / El escape de aire (3) debe estar orientado hacia abajo.

Modification	4				Drawn		
	3				09/06/14 A.U.		
	2				Checked		
	1				09/06/14 A.L.		
	nº	Modified	Date	Reason	General Tolerance	Assembly	
Comments					-	Part name	Air Dryer / Secador de aire
					Material	ID. Reference	2210106
					-	Scale: -	
					-	Review: 0	

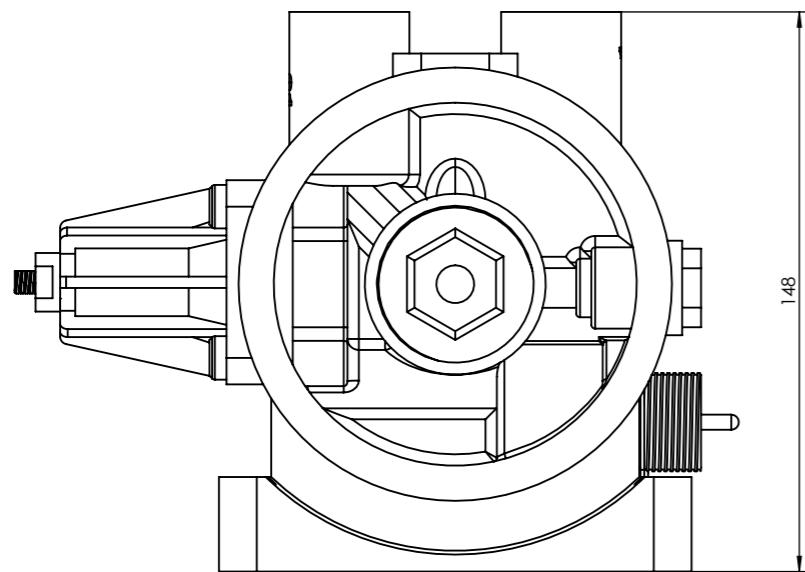
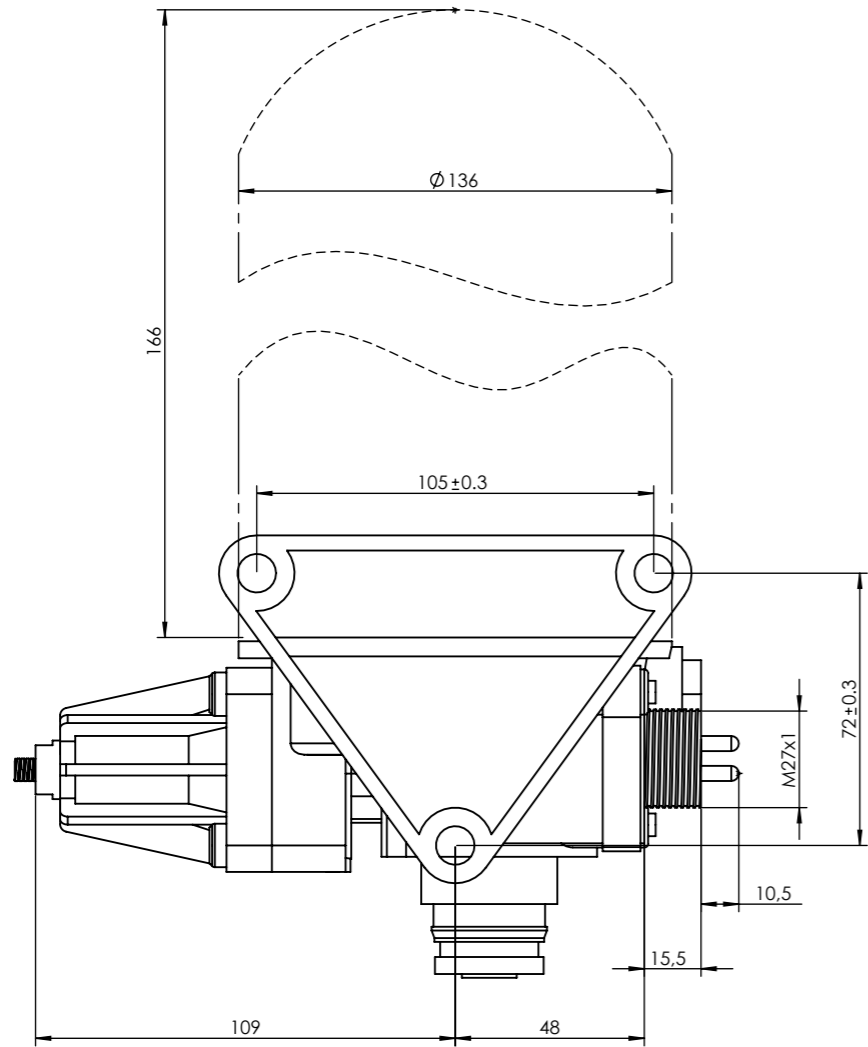

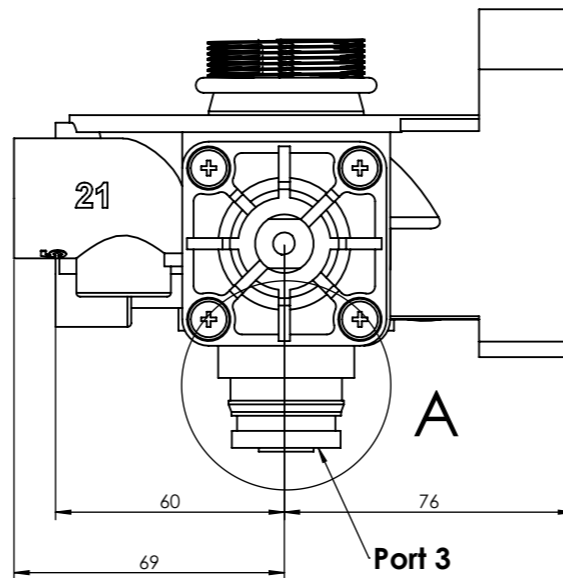
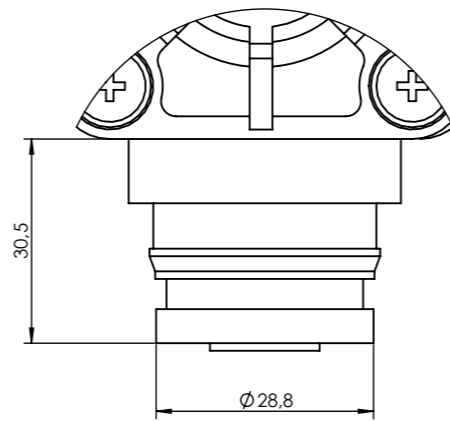

DETAIL / DETALLE A
SCALE / ESCALA 1 : 1

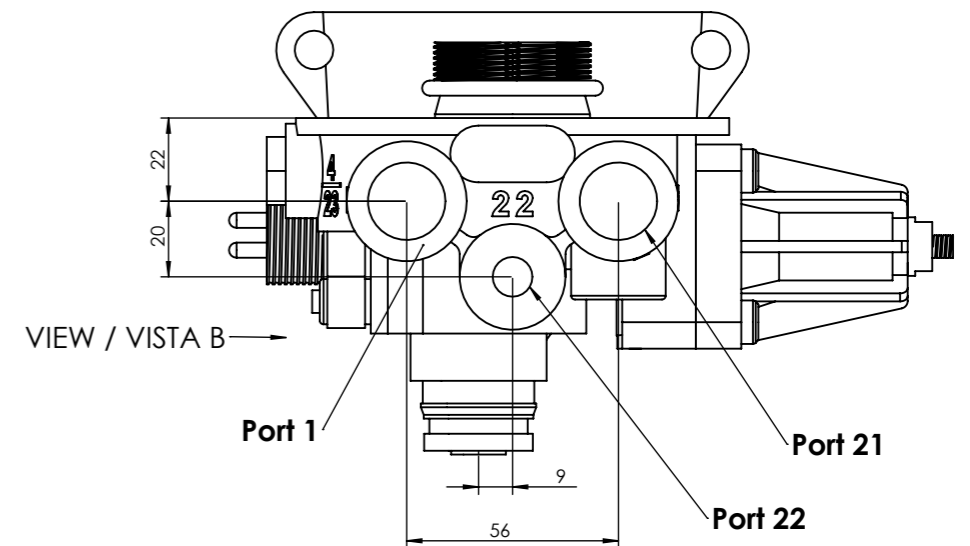
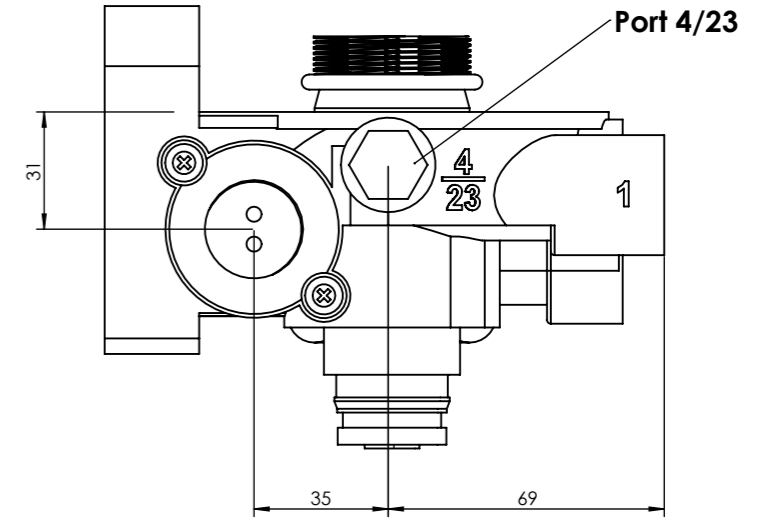

VIEW / VISTA B



Modification	4			Drawn		F
	3			09/06/14 A.U.		
	2			Checked		
	1			09/06/14 A.L.		
	nº Modified	Date	Reason	General Tolerance	Assembly	-
Comments				ISO 2768 c-K	Part name	Air Dryer / Secador de aire
				Material	ID. Reference	2210106
					Scale: 1/2	
					Review: 0	