

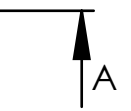

SECTION A-A

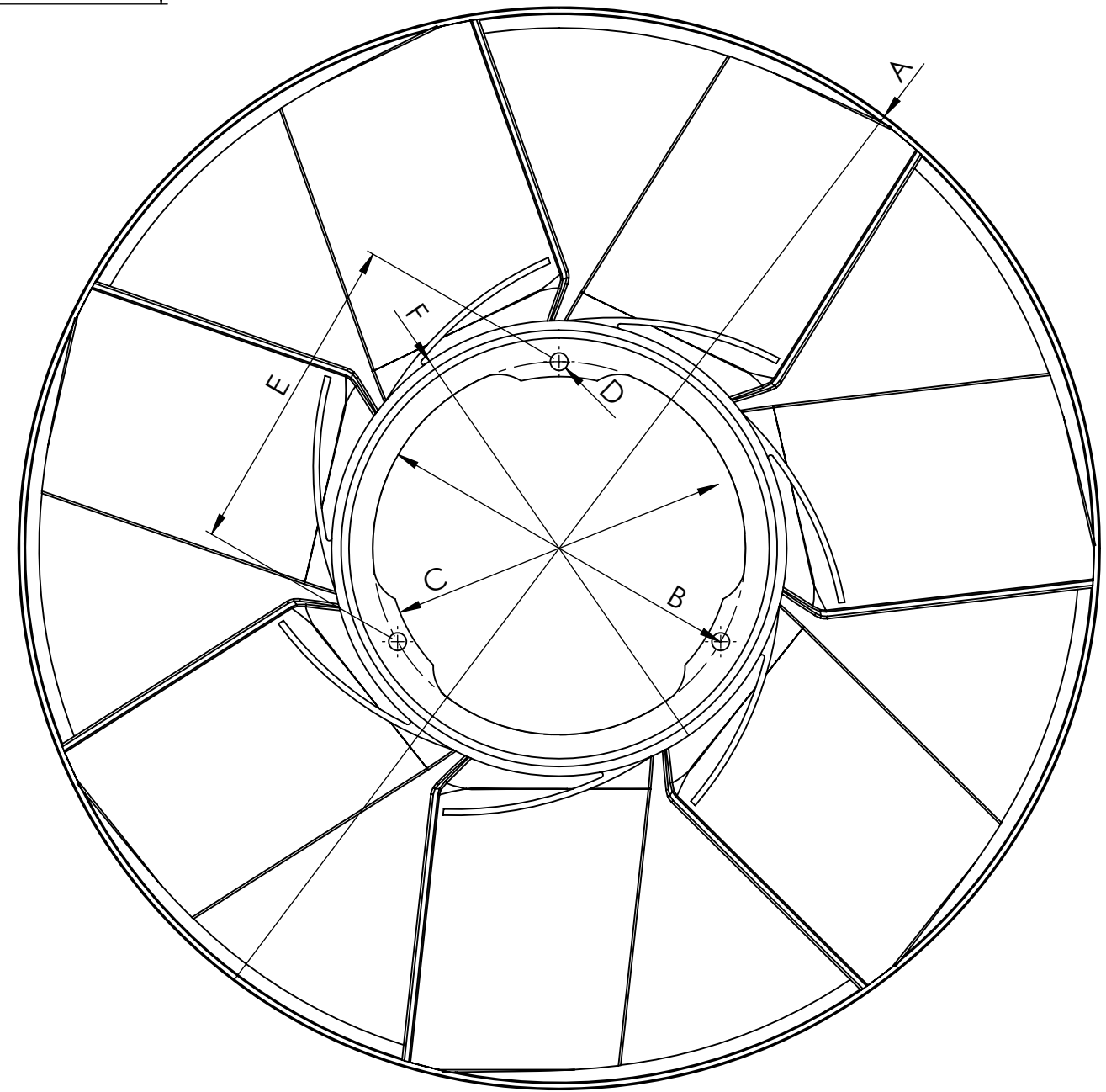
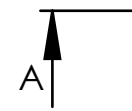
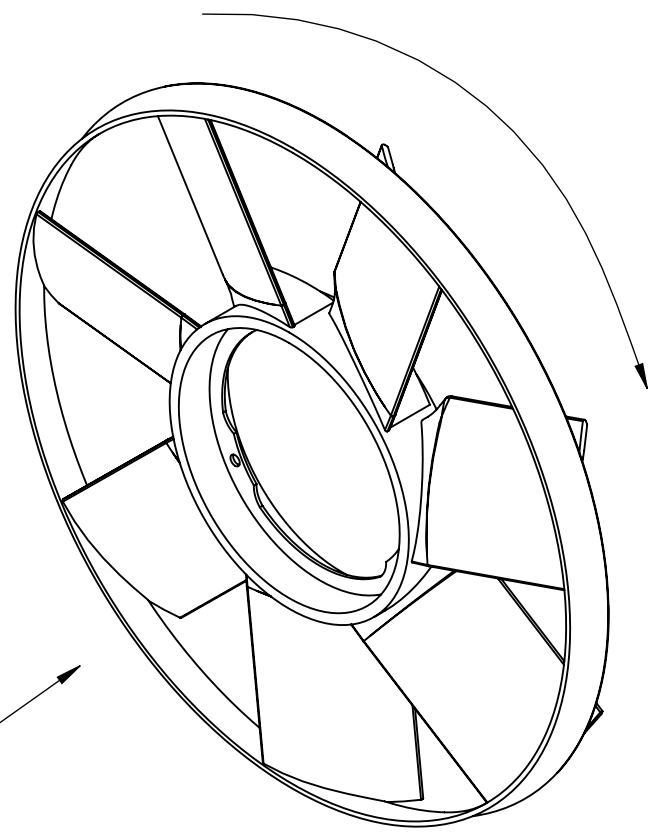

FAN WHEEL			
Ref.n°	Value	Ref.n°	Value
A	$\phi 425 \pm 3$ mm	G	40 ± 3 mm
B	$\phi 147$ mm	H	17 ± 3 mm
C	$\phi 135 +0.30$ mm	I	40 ± 3 mm
D	3x $\phi 7$ mm	J	$\phi 415 \pm 3$ mm
E	127.3 mm		
F	$\phi 179 \pm 3$ mm		
Number of blades		7	Configuration
			CW

Modification n°	Modified	Date	Reason	Comments
3				
2				
1				

Drawn
16/06/20 A.G.
Checked
16/06/20 R.U.

General Tolerance
ISO 2768 c-K
Material

Assembly
Part name Fan wheel
ID. Reference 8111610
Scale: 2/5
Review: 0

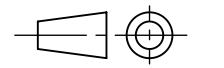

Sheet
1/1