

1

2

3

4

A

Technical Data/ Datos Técnicos:

A

Part number adaptable to/ Referencia adaptable a:	4220100100
Hydraulic fluid/ Fluido hidráulico:	Air/Aire
Thermal range/ Rango de temperatura:	-40 °C to/ a 80 °C
Supply pressure/ Presión de alimentación:	max. 10 bar
Stroke/ Carrera:	57 mm
Weight/ Peso:	1145 gr

B

B

C

C

**Pneumatic scheme
/
Esquema neumático**

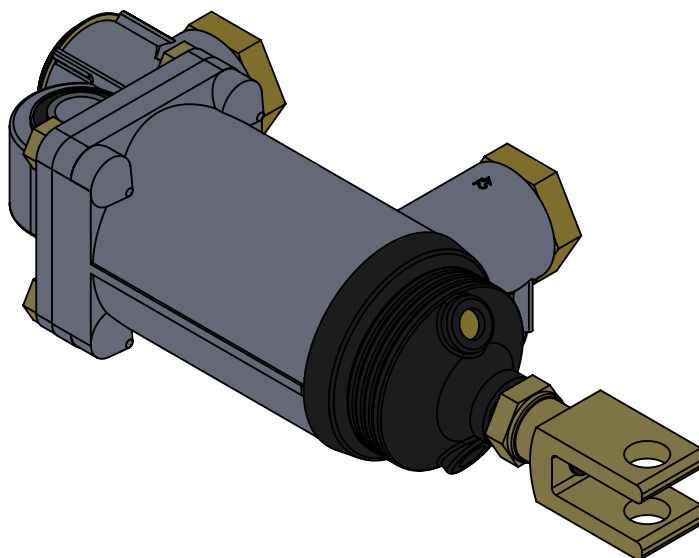
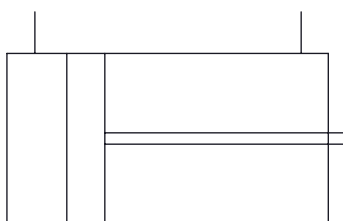

D

D

E

E

F

F

Modification	4				Drawn		
	3				02/09/20 S.F.		
	2				Checked		
	1				02/09/20 O.V.		
	nº	Modified	Date	Reason	General Tolerance		Assembly
Comments					-	Part name	Operating cylinder/cilindro operacional
					Material	ID. Reference	2202100
					-	Scale: -	
					-	Review: 0	

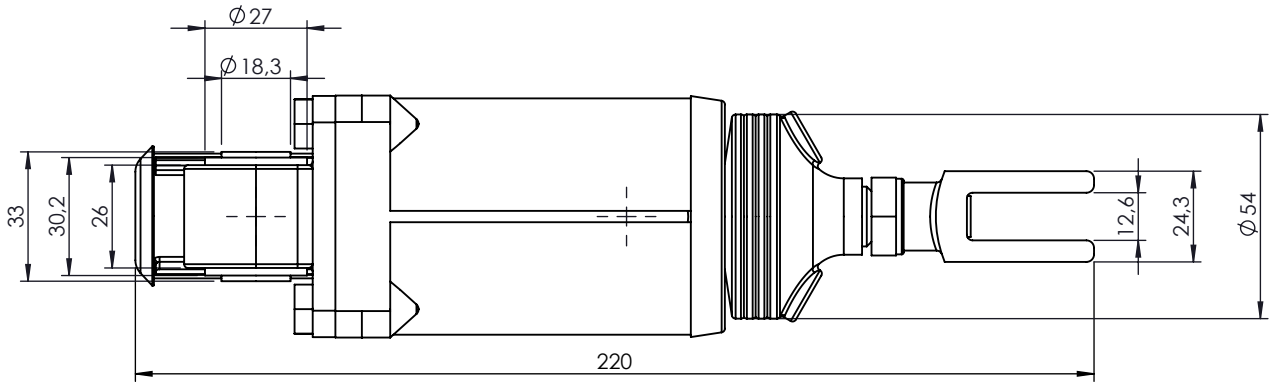
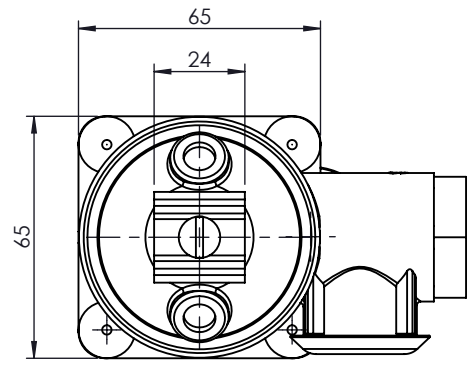
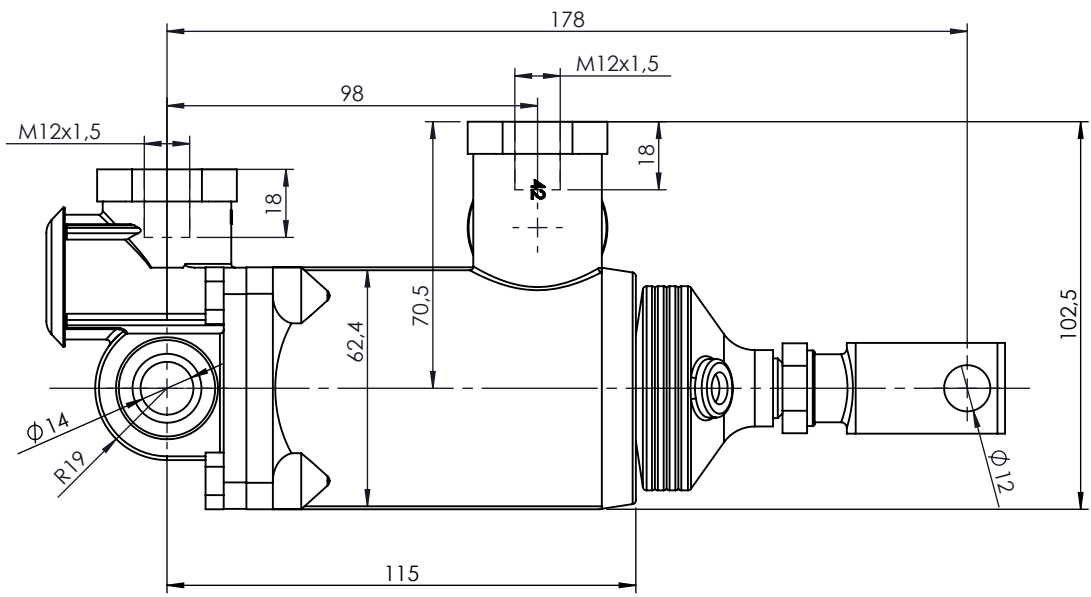

Modification	4				Drawn		
	3				02/09/20 S.F.		
	2				Checked		
	1				02/09/20 O.V.		
	nº	Modified	Date	Reason	General Tolerance	Assembly	
Comments					-	Part name	Operating cylinder/Cilindro operacional
					Material	ID. Reference	2202100
						Scale: -	
						Review: 0	

