

**Technical data/ Datos técnicos:**

According to/ En referencia a:	20508011
Operating temperature range/ Rango de temperatura:	-40°C a/to 80°C
Weight/Peso:	107 gr

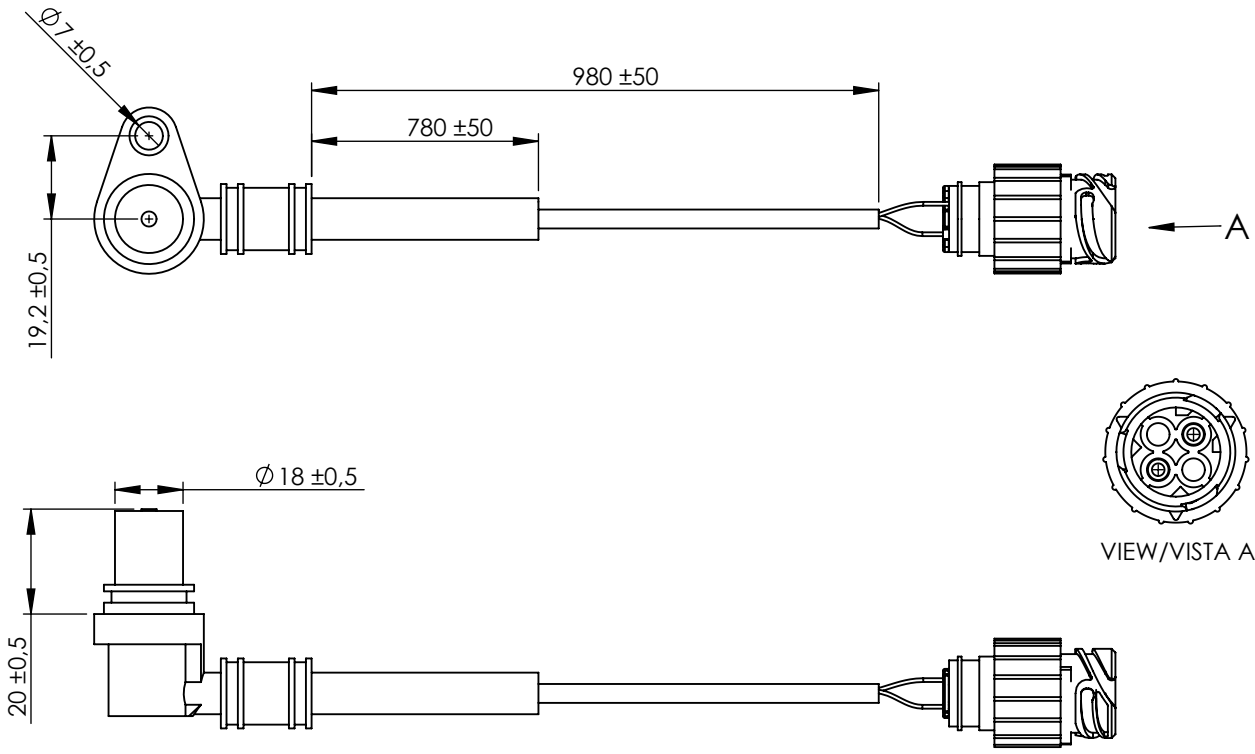

F	Modification	4				Drawn	
		3				07/08/20 S.F.	
		2				Checked	
		1				07/08/20 E.L.	
	nº	Modified	Date	Reason	General Tolerance	Assembly	
Comments					ISO 2768 c-K	Part name	RPM sensor/Sensor de revoluciones
					Material	ID. Reference	2260178
					-	Scale: 1/2	
					-	Review: 0	