

1

2

3

4

A

Technical sheet / Datos técnicos:

A

Part number adaptable to / Referencia adaptable a	4613074720
Operating pressure / Presión de trabajo	max. 8 bar
Predominance / Predominancia	≤ 0,3 bar
Permissible medium / Medio de funcionamiento	Air / Aire
Operating temperature range / Rango de temperatura	-40 °C to / a +80 °C
Weight / Peso	1700 gr

B

B

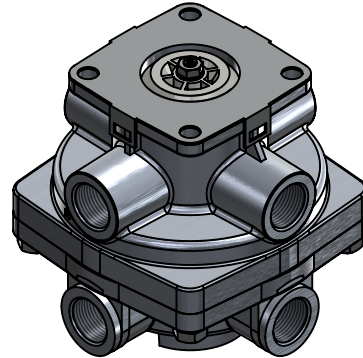
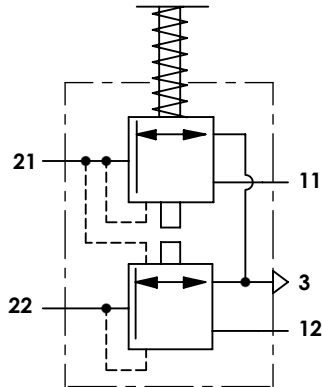

C

C

Port / Conexión	Function / Función	Thread / Rosca
11	Supply / Alimentación	M22x1,5
12	Supply / Alimentación	M22x1,5
21	Delivery / Salida	3x M22x1,5
22	Delivery / Salida	3x M22x1,5
3	Exhaust / Escape	-

D

D

Purpose / Propósito:

Application of service brake system through the pedal actuation by the driver. / Aplicación del freno de servicio mediante la actuación del pedal por parte del conductor.

Installation requirements / Requisitos para la instalación:

The design of the foot brake valve, acting on seat, must guarantee the maximum way of the push rod that is necessary to control the valve even in case of failure in the circuit I. Mounting is accomplished with four screws M8. / El diseño de la válvula de freno de pie, accionándolo desde el asiento, debe garantizar el máximo recorrido de la varilla de empuje que resulta necesario para el accionamiento de la válvula, incluso en caso de que falle el circuito I. El montaje se efectúa con cuatro tornillos M8.

E

E

F	Modification	4				Drawn	
		3				12/08/15 A.U.	
		2				Checked	
		1				12/08/15 A.L.	
		nº	Modified	Date	Reason	General Tolerance	
Comments					-	Part name	Foot brake valve
					Material	ID. Reference	2212119
					-	Scale: -	
					-	Review: 0	

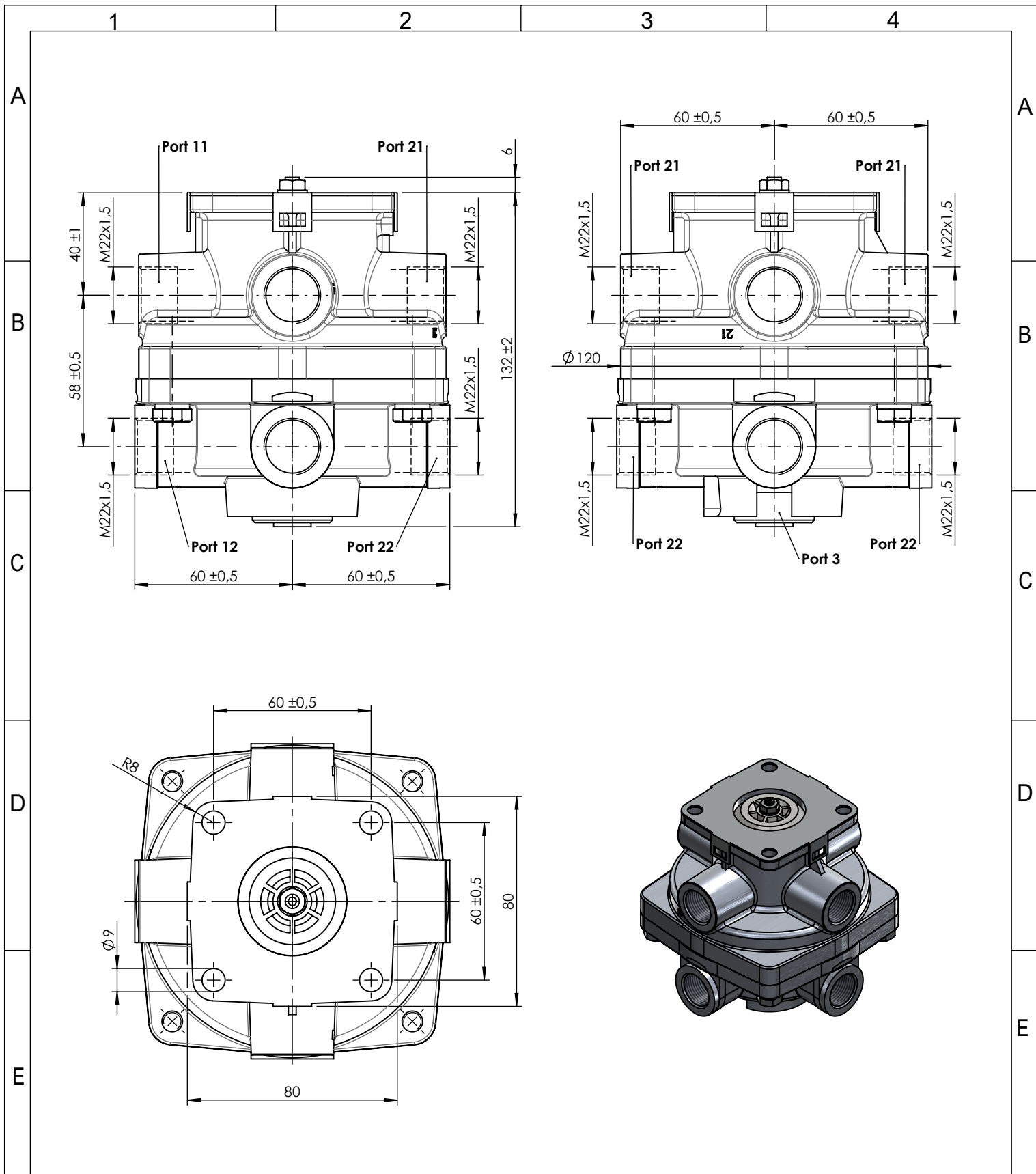

F	Modification	4				Drawn	
		3				12/08/15 A.U.	
		2				Checked	
		1				12/08/15 A.L.	
		nº	Modified	Date	Reason	General Tolerance	
	Comments				ISO 2768 c-K	Part name	Foot brake valve
					Material	ID. Reference	2212119
					-	Scale: 1/2	
					-	Review: 0	