

1

2

3

4

Technical sheet / Datos técnicos:

Part number adaptable to / Referencia adaptable a	93096
Operating pressure / Presión de trabajo	max. 13 bar
Unloader / Regulador de presión	Integrated / Integrado
Cut-out pressure / Presión de corte	10,8 ± 0,2 bar
Heating / Calentador	-
Permissible medium / Medio de funcionamiento	Air / Aire
Operating temperature range / Rango de temperatura	-40°C to / a +80°C
Weight / Peso	6050 gr

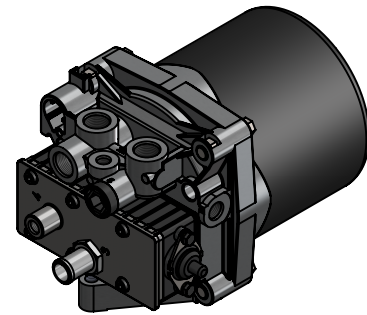
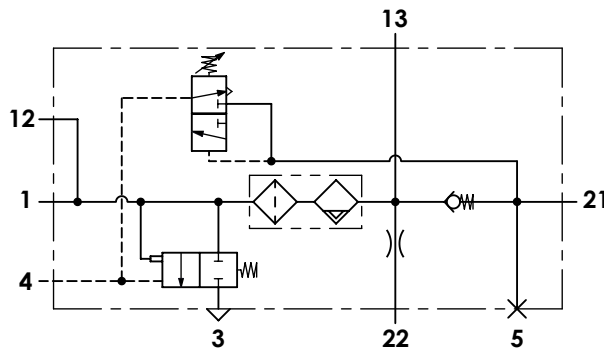

Port / Conexión	Function / Función	Thread / Rosca
1	Supply from air compressor / Alimentación desde el compresor	M22x1,5
12	External filling / Llenador exterior	M22x1,5
13	Auxiliary inlet / Entrada auxiliar	M16x1,5
21	Delivery to air reservoirs / Salida a los calderines	M22x1,5
22	Delivery to air regeneration reservoir / Salida al calderín de regeneración	M12x1,5
3	Exhaust / Escape	-
4	Control / Pilotaje	M12x1,5
5	Auxiliary output / Salida auxiliar	Closed / Taponada

Purpose / Propósito:

Drying of the compressed air supplied by the compressor. / Secado del aire comprimido procedente del compresor.

Installation requirements / Requisitos para la instalación:

Exhaust (3) must look down. / El escape (3) debe estar orientado hacia abajo.

Modification	4				Drawn		
	3				27/06/18 J.S.		
	2				Checked		
	1				27/06/18 O.V.		
	nº	Modified	Date	Reason	General Tolerance		Assembly
Comments					-	Part name	Air dryer
					Material	ID. Reference	2410016
					-	Scale: -	
					-	Review: 0	

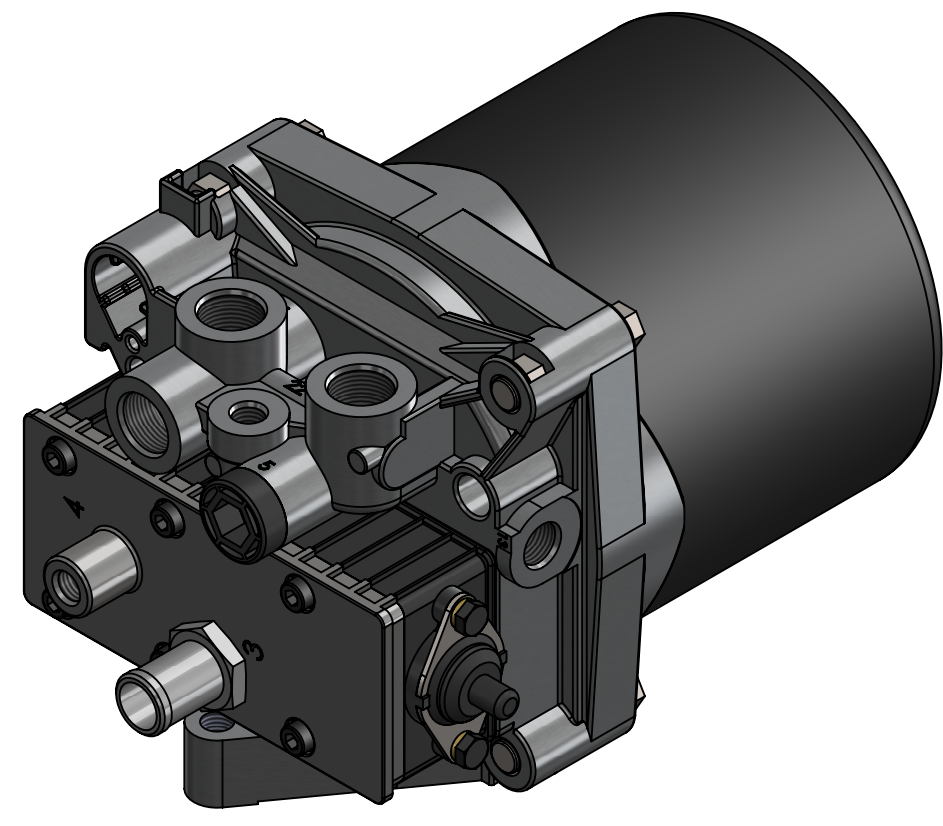
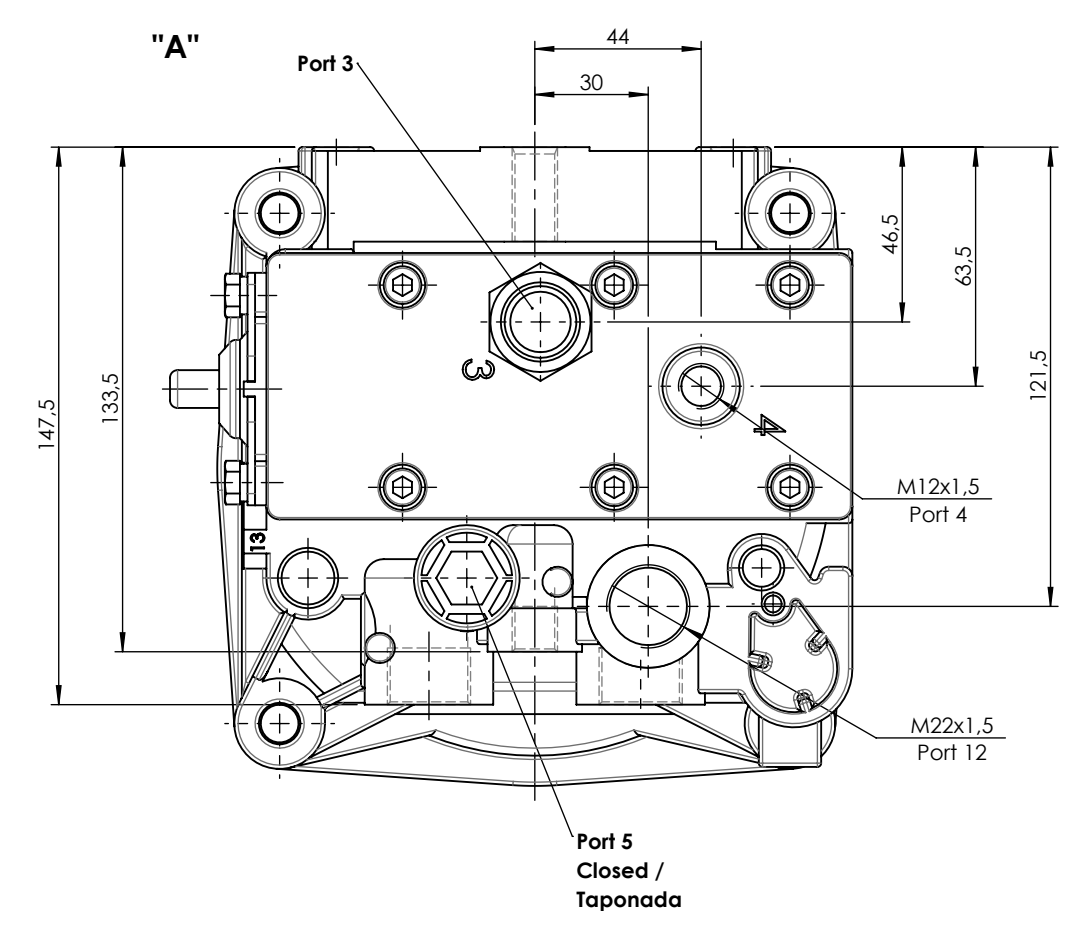
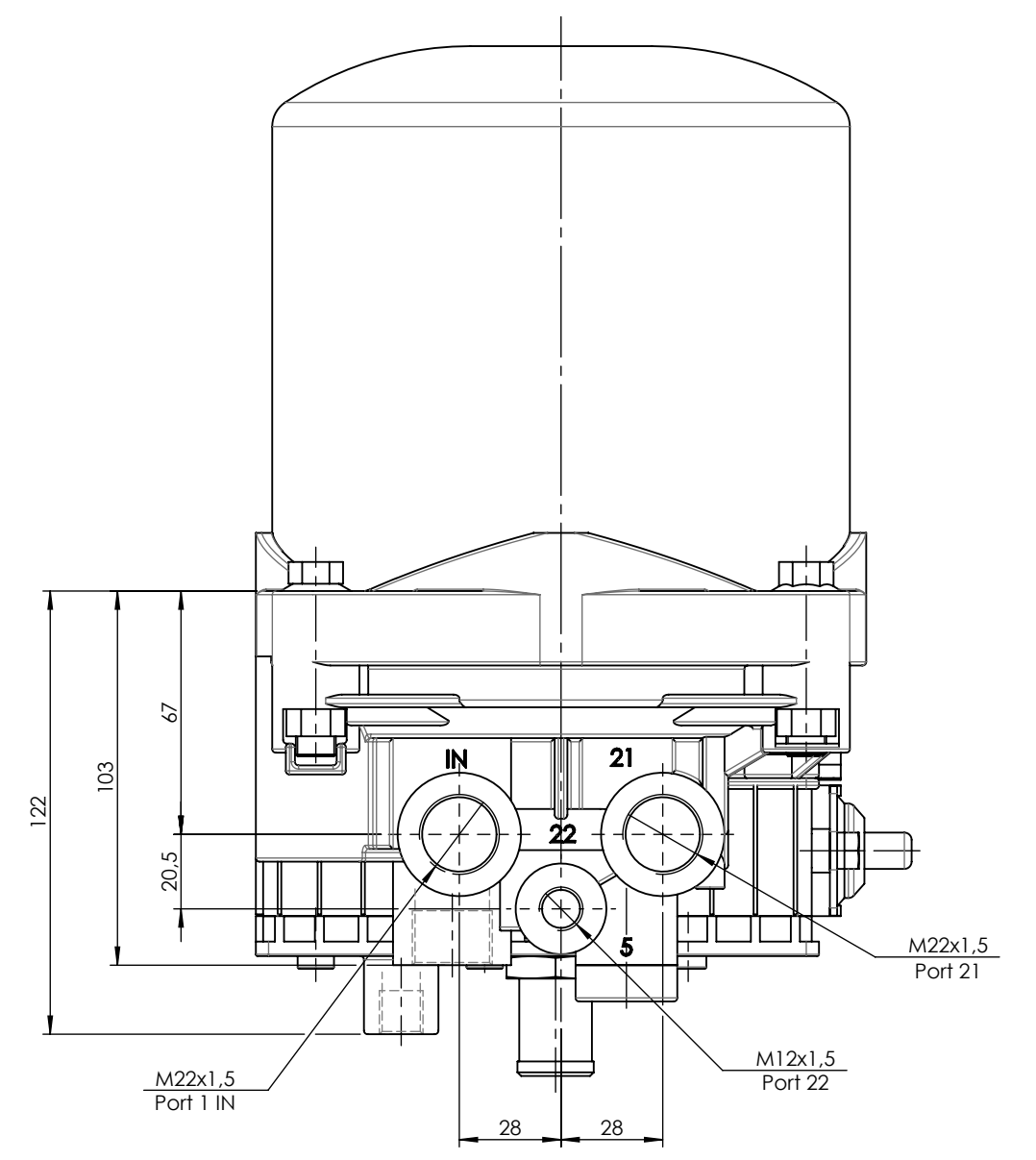
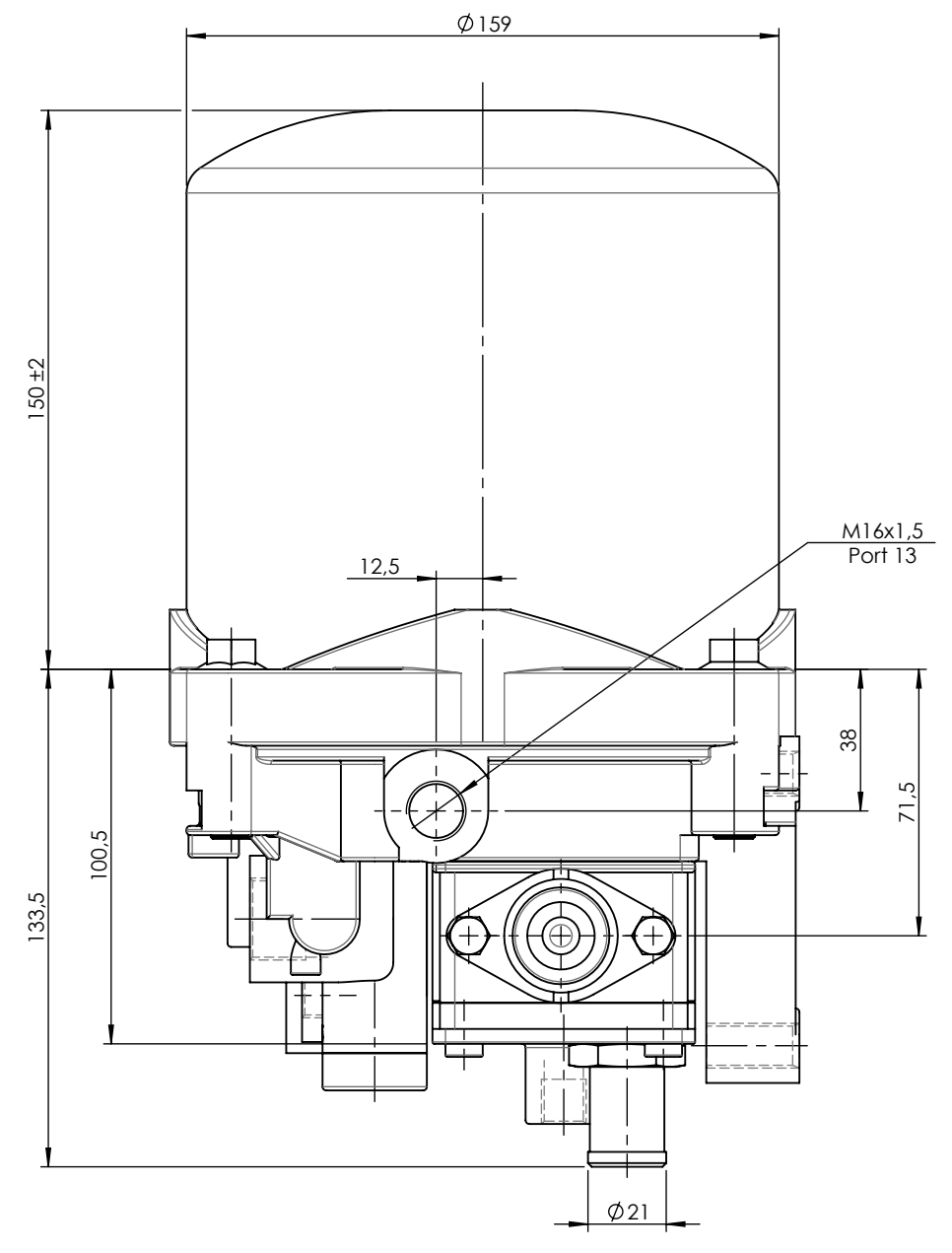
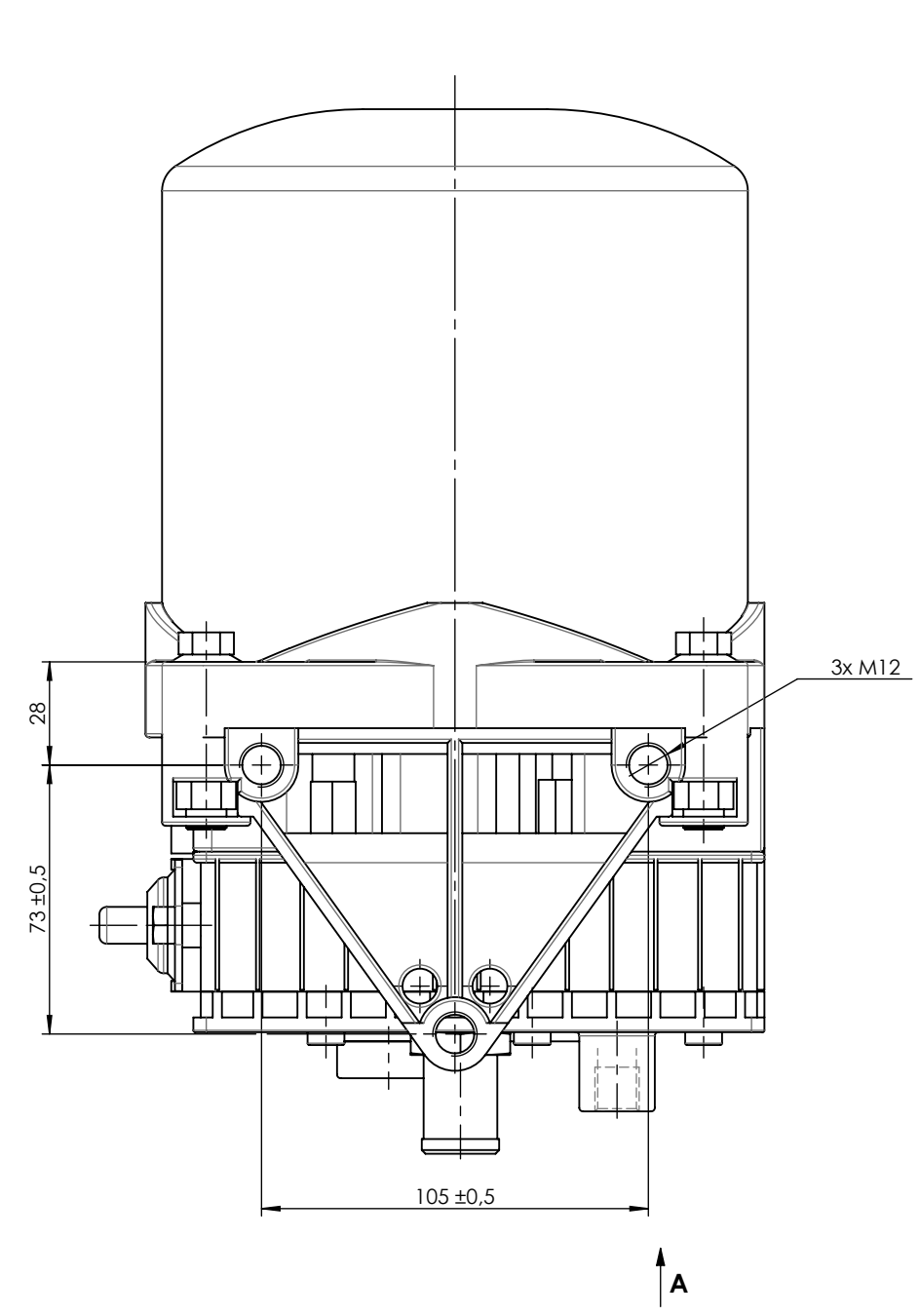

Modification	4			Drawn		
	3			27/06/18 J.S.		
	2			Checked		
	1			27/06/18 O.V.		
	nº Modified	Date	Reason	General Tolerance	Assembly	-
Comments				ISO 2768 c-K	Part name	Air dryer
				Material	ID. Reference	2410016
					Scale: 1/2	
					Review: 0	

