

Technical sheet / Datos técnicos:

Part number adaptable to / Referencia adaptable a	4757111240
Operating pressure / Presión de trabajo	max. 13 bar
Regulation index / Índice de regulación	1 : 8
Permissible medium / Medio de funcionamiento	Air / Aire
Operating temperature range / Rango de temperatura	-40°C to / a +80°C
Weight / Peso	2100 gr

Pressure regulation / Regulación de presión

Position / Posición	P1	P4	P2
P41/42 = 0.2 bar	6.4 bar	6.4 bar	1.5 bar
P41/42 = 2.8 bar	6.4 bar	6.4 bar	4.75 bar

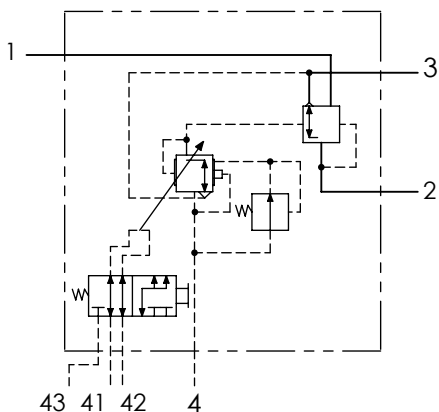

Port / Conexión	Function / Función	Thread / Rosca
1	Supply / Alimentación	M22x1.5 VOSS
2	Delivery / Salida	2x M22x1.5 VOSS
3	Exhaust / Escape	-
4	Control / Pilotaje	M16x1.5 VOSS
41	Suspension control / Pilotaje suspensión	M16x1.5 VOSS
42	Suspension control / Pilotaje suspensión	M16x1.5 VOSS
43	Test / Test	M16x1.5

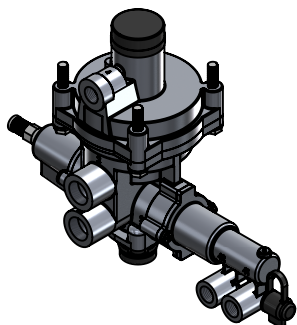

Purpose / Propósito: The automatically control braking force on the air brake chambers of vehicles with air suspended axles. Automatic control is dependent upon the air bag pressure which corresponds to the vehicle load. / El control automático de la fuerza de frenado en las cámaras de freno de aire comprimido de los vehículos con ejes dotados de suspensión neumática. El control automático depende de la presión del colchón neumático que corresponde a la carga del vehículo.

Installation requirements / Requisitos para la instalación: The valve must be installed vertically with the exhaust port (3) pointing downwards. Mounting is accomplished with at least 2 screws M8. / La válvula debe fijarse verticalmente con el escape (3) orientado hacia abajo. El montaje se realiza con, al menos, 2 tornillos M8.

Modification	4				Drawn			
	3				17/02/11 A.U.			
	2				Checked			
	1				17/02/11 A.L.			
	nº	Modified	Date	Reason	General Tolerance		Assembly	-
Comments					-	Part name	ALB	
					Material	ID. Reference	2220457	
					-	Scale: -		Sheet 1/2
					-	Review: 0		

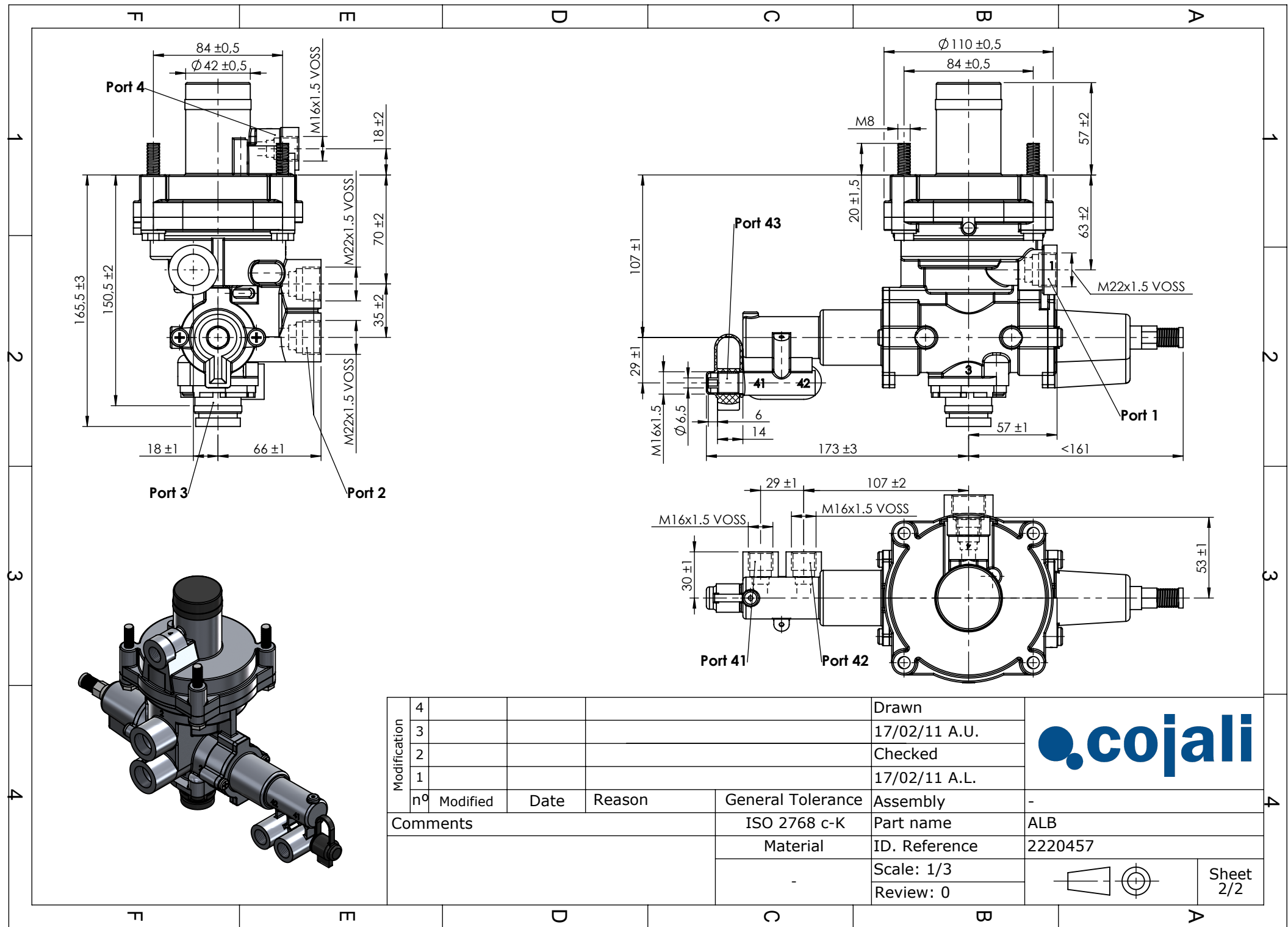

Modification	4				Drawn	
	3				17/02/11 A.U.	
	2				Checked	
	1				17/02/11 A.L.	
n°	Modified	Date	Reason	General Tolerance	Assembly	
Comments					ISO 2768 c-K	Part name
					Material	ID. Reference
						Scale: 1/3
						Review: 0

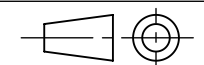

Sheet
2/2