

1

2

3

4

A

Technical sheet / Datos técnicos:

A

Part number adaptable to / Referencia adaptable a	4340141000
Working pressure / Presión de trabajo	max 20 bar
Permissible medium / Medio de funcionamiento	Air / Aire
Operating temperature range / Rango de temperatura	-40 °C to / a +80 °C
Weight / Peso	70 gr

B

B

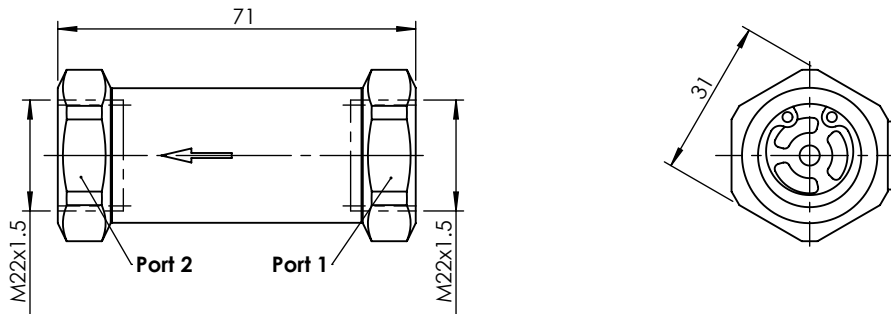

C

C

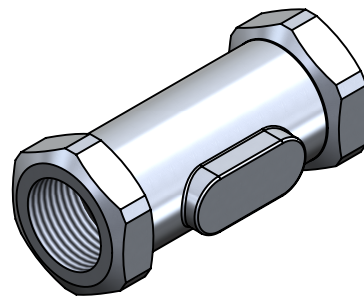
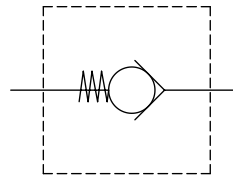

D

D

Port / Conexión	Function / Función	Thread / Rosca
1	Supply / Alimentación	M22x1.5
2	Delivery / Salida	M22x1.5

E

E

Purpose / Propósito: To let the air passes in one direction and to block the air passage in the opposite direction. / Permitir el paso de aire en una dirección y bloquear el paso de aire en la dirección opuesta.

Installation requirements / Requisitos para la instalación: The direction of the arrow on the aluminium body indicates the direction of air flow that is allowed. / La dirección de la flecha del cuerpo de aluminio indica el flujo de paso de aire permitido.

F

F

Modification	4				Drawn	
	3				18/12/14 A.U.	
	2				Checked	
	1				18/12/14 A.L.	
nº	Modified	Date	Reason	General Tolerance	Assembly	-
Comments				ISO 2768 c-K	Part name	Non-return valve
				Material	ID. Reference	2205102
				-	Scale: 2/3	
				-	Review: 0	